



TOLL FREE

1.800.321.7950 | WHEELERREX.COM

**WE TAKE QUALITY
PERSONALLY.**



4-9 PIPE CUTTERS

Manual & Ratchet Snap Cutters
Hydraulic Pipe Cutters
Replacement Cutter Chains
Internal Cast Iron Pipe Cutter
Steel Pipe Cutters
Hinged Pipe Cutters
The PipeMaster

10-23 PLASTIC PIPE & COPPER TUBE TOOLS

Glass Tubing Cutters
Professional & Economy Snippers
Plastic Pipe Saws
Hand And Powered Bevelers
Pipe Hog
Internal Plastic Pipe Cutters
Chamfering/Depth Gauge Tool
Guillotine Pipe Cutters
PEX Crimping Tools
Utility Knives
Tubing Cutters
Close Quarters Cutter
Auto-C Cutters
Ratch Cuts
Tube Brushes
Inner & Outer Reamer
Deburring Tool
Hammerhead Flaring Tool
Rerounding Tools and Kit
Replacement Cutter Wheels

24-25 GROOVING & FABRICATION

Portable Roll Groovers
Hydraulic Grooving Machines
Orbital Pipe Cutting Machine
Mantis Blades

26-35 PIPE THREADING

Manual Ratchet Threader Sets
Mini Power Drivers
Hand Oiler
12R Style Dies – NPT, BSPT
12R Style Drop Head with Dies
Sidekick III Pipe Threader
Power Threading Machines
Universal Replacement Dies
Threader Cart & Stands
Nipple Attachments
Threadmaster Cutting Oil

36-40 HYDROSTATIC TEST PUMPS

Manual Operated
Gas Operated
Electric Operated
Pneumatic Operated
Fire Hose Testers

41 TRASH PUMP

2" and 3" Trash Pumps
Mudsucker Pumps
Vacuum Test Assembly

42-48 PIPE WORKING TOOLS

Tripod Vise Stands
Bench Vises
Pipe Supports
Yoke Vises
Floor Pipe Vises
Pipe Puller
Pipe Dolly
Pipe Wrenches
Spud Wrench
Chain Wrench
Strap Wrenches
Basin Wrench
Coupling Torque Wrenches
Hydrant Wrench
Double-Up Wrenches
Heavy Duty Deep Sockets
O.D. Tapes
Pipe Descaler
Pipe Freezing Kit

49 SHUTOFF TOOLS

Soft Copper Water Lines
Plastic Water and Gas Lines

50-53 DRILLING & TAPPING TOOLS

Hot Tap System & Accessories
Drill Taps
Tapping Fluid
Portable Hole Cutter Systems
Hole Cutter System and Sheels
Earthworm Hydro-Drill
Pipe Slices & Accessories
Mini Pipe Slice

54-55 VALVE EXERCISERS

ValveMaster
Portable Valve Exercisers
Aluminum Valve Wheel Wrenches
Hydrant Nut
Rising Stem & Hand Wheel
Adapters
Telescoping Valve Key

56 MARKETING TOOLS

58-63 PRODUCT LISTING

PIPE CUTTERS



590 AND 591 MANUAL PIPE CUTTER



| Wheeler # | Service (Std) WT Soil Pipe | XH Soil Pipe | No-Hub® | Tile / Clay | Shipping Weight |
|-----------|----------------------------|------------------------|------------------------|----------------------|------------------|
| 590-6 | 1 1/2"-6" (38mm-150mm) | 1 1/2"-5" (38mm-125mm) | 1 1/2"-6" (38mm-150mm) | 4"-6" (100mm-150mm) | 23 lbs. (10.5kg) |
| 590-8 | 1 1/2"-6" (38mm-150mm) | 1 1/2"-5" (38mm-125mm) | 1 1/2"-6" (38mm-150mm) | 4"-8" (100mm-200mm) | 25 lbs. (11.5kg) |
| 590-10 | 1 1/2"-6" (38mm-150mm) | 1 1/2"-5" (38mm-125mm) | 1 1/2"-6" (38mm-150mm) | 4"-10" (100mm-250mm) | 28 lbs. (13kg) |
| 590-12 | 1 1/2"-6" (38mm-150mm) | 1 1/2"-5" (38mm-125mm) | 1 1/2"-6" (38mm-150mm) | 4"-12" (100mm-300mm) | 28 lbs. (12.7kg) |
| 590-15 | 1 1/2"-6" (38mm-150mm) | 1 1/2"-5" (38mm-125mm) | 1 1/2"-6" (38mm-150mm) | 4"-15" (100mm-375mm) | 29 lbs. (13kg) |
| 591-6 | 1 1/2"-6" (38mm-150mm) | 1 1/2"-5" (38mm-125mm) | 1 1/2"-6" (38mm-150mm) | 4"-6" (100mm-150mm) | 24 lbs. (11kg) |
| 591-8 | 1 1/2"-6" (38mm-150mm) | 1 1/2"-5" (38mm-125mm) | 1 1/2"-6" (38mm-150mm) | 4"-8" (100mm-200mm) | 25 lbs. (11.5kg) |

38 Replacement Adjustment Screw Assembly



Close-up view of "captured screw"

490 AND 491 RATCHET PIPE CUTTER



| Wheeler # | Service (Std) WT Soil Pipe | XH Soil Pipe | No-Hub® | Tile / Clay | Shipping Weight |
|-----------|----------------------------|------------------------|------------------------|----------------------|------------------|
| 490-6 | 1 1/2"-6" (38mm-150mm) | 1 1/2"-5" (38mm-125mm) | 1 1/2"-6" (38mm-150mm) | 4"-6" (100mm-150mm) | 18 lbs. (8.5kg) |
| 490-8 | 1 1/2"-6" (38mm-150mm) | 1 1/2"-5" (38mm-125mm) | 1 1/2"-8" (38mm-200mm) | 4"-8" (100mm-200mm) | 19 lbs. (8.6kg) |
| 490-10 | 1 1/2"-6" (38mm-150mm) | 1 1/2"-5" (38mm-125mm) | 1 1/2"-8" (38mm-200mm) | 4"-10" (100mm-250mm) | 20 lbs. (9.5kg) |
| 490-12 | 1 1/2"-6" (38mm-150mm) | 1 1/2"-5" (38mm-125mm) | 1 1/2"-8" (38mm-200mm) | 4"-12" (100mm-300mm) | 22 lbs. (10kg) |
| 490-15 | 1 1/2"-6" (38mm-150mm) | 1 1/2"-5" (38mm-125mm) | 1 1/2"-8" (38mm-200mm) | 4"-15" (100mm-375mm) | 23 lbs. (10.5kg) |
| 491-6 | 1 1/2"-6" (38mm-150mm) | 1 1/2"-5" (38mm-125mm) | 1 1/2"-6" (38mm-150mm) | 4"-6" (100mm-150mm) | 18 lbs. (8.5kg) |
| 491-8 | 1 1/2"-6" (38mm-150mm) | 1 1/2"-5" (38mm-125mm) | 1 1/2"-8" (38mm-200mm) | 4"-8" (100mm-200mm) | 19 lbs. (9kg) |

6519 1/2" Square Male/Female Drive Ratchet 2 lbs. (0.9kg)

700669 Replacement Drive Screw Assembly

275556 Replacement Pin for 700669

3990 XH RATCHET PIPE CUTTER



| Wheeler # | Service (Std) WT Soil Pipe | XH Soil Pipe | Tile / Clay | Cast Iron Water Class 22 | Shipping Weight |
|-----------|----------------------------|--------------------|---------------------|--------------------------|------------------|
| 3990-6 | 2"-6" (50mm-150mm) | 2"-6" (50mm-150mm) | 2"-6" (50mm-150mm) | 2"-6" (50mm-150mm) | 21 lbs. (9.5kg) |
| 3990-8 | 2"-8" (50mm-200mm) | 2"-8" (50mm-200mm) | 4"-8" (100mm-200mm) | 2"-6" (50mm-150mm) | 23 lbs. (10.5kg) |

6520 1/2" Square Female Drive Ratchet – U.S.A. Made 2 lbs. (0.9kg)

700919 Replacement Drive Screw Assembly

WHEELER-REX HYDRAULIC PIPE CUTTERS

WHEELER-REX Hydraulic Cutters are the solution to cutting larger diameter Cast Iron, Tile and Concrete Pipe. Like the hand operated "snap" cutters, hydraulic cutters are not rotated around pipe. Their remotely operated hydraulic pumps provide the required power. A 2"-3" minimum clearance is all that is needed to wrap cutter chain around pipe. They come complete with pump, hose and case.



2990 HYDRAULIC PIPE CUTTER

| Wheeler # | Service (Std) WT Soil Pipe | XH Soil Pipe | Tile / Clay | Cast Iron Water Class 22 | Cast Iron Water Class 26 | Shipping Weight |
|-----------|----------------------------|--------------------|---------------------|--------------------------|--------------------------|-----------------|
| 2990-6 | 2"-6" (50mm-150mm) | 2"-6" (50mm-150mm) | 2"-6" (50mm-150mm) | 2"-6" (50mm-150mm) | NA | 85 lbs. (39kg) |
| 2990-8 | 2"-8" (50mm-200mm) | 2"-8" (50mm-200mm) | 2"-8" (50mm-200mm) | 2"-6" (50mm-150mm) | NA | 87 lbs. (40kg) |
| 2990-10 | 2"-10" (50mm-250mm) | 2"-8" (50mm-200mm) | 2"-10" (50mm-250mm) | 2"-6" (50mm-150mm) | NA | 89 lbs. (41kg) |
| 2990-12 | 2"-10" (50mm-250mm) | 2"-8" (50mm-200mm) | 2"-12" (50mm-300mm) | 2"-6" (50mm-150mm) | NA | 92 lbs. (42kg) |
| 2990-15 | 2"-10" (50mm-250mm) | 2"-8" (50mm-200mm) | 2"-15" (50mm-375mm) | 2"-6" (50mm-150mm) | NA | 94 lbs. (43kg) |

1630 Replacement Hydraulic Pump 22 lbs. (48.5kg)



3890 HYDRAULIC PIPE CUTTER

| Wheeler # | Service (Std) WT Soil Pipe | XH Soil Pipe | Tile and Concrete | Cast Iron Water Class 22 | Cast Iron Water Class 26 | Shipping Weight |
|-----------|----------------------------|----------------------|----------------------|--------------------------|--------------------------|-----------------|
| 3890-12 | 4"-12" (100mm-300mm) | 4"-12" (100mm-300mm) | 4"-12" (100mm-300mm) | 4"-12" (100mm-300mm) | 4"-10" (100mm-250mm) | 152 lbs. (69kg) |
| 3890-15 | 4"-15" (100mm-375mm) | 4"-15" (100mm-375mm) | 4"-15" (100mm-375mm) | 4"-12" (100mm-300mm) | 4"-10" (100mm-250mm) | 163 lbs. (74kg) |
| 3890-18 | 4"-18" (100mm-450mm) | 4"-18" (100mm-450mm) | 4"-18" (100mm-450mm) | 4"-12" (100mm-300mm) | 4"-10" (100mm-250mm) | 170 lbs. (77kg) |
| 3890-24 | 4"-18" (100mm-450mm) | 4"-18" (100mm-450mm) | 4"-24" (100mm-600mm) | 4"-12" (100mm-300mm) | 4"-10" (100mm-250mm) | 178 lbs. (88kg) |

1830 Replacement Hydraulic Pump 22 lbs. (48.5kg)



5590 HYDRAULIC PIPE CUTTER

| Wheeler # | Service (Std) WT Soil Pipe | XH Soil Pipe | Tile and Concrete | Cast Iron Water Class 22 | Cast Iron Water Class 26 | Shipping Weight |
|-----------|----------------------------|----------------------|----------------------|--------------------------|--------------------------|------------------|
| 5590-18 | 6"-18" (150mm-450mm) | 6"-18" (150mm-450mm) | 6"-18" (150mm-450mm) | 6"-18" (150mm-450mm) | 6"-18" (150mm-450mm) | 200 lbs. (91kg) |
| 5590-20 | 6"-18" (150mm-450mm) | 6"-18" (150mm-450mm) | 6"-20" (150mm-500mm) | 6"-20" (150mm-500mm) | 6"-18" (150mm-450mm) | 213 lbs. (97kg) |
| 5590-24 | 6"-18" (150mm-450mm) | 6"-18" (150mm-450mm) | 6"-24" (150mm-600mm) | 6"-20" (150mm-500mm) | 6"-18" (150mm-450mm) | 230 lbs. (105kg) |
| 5590-36 | 6"-18" (150mm-450mm) | 6"-18" (150mm-450mm) | 6"-36" (150mm-900mm) | 6"-20" (150mm-500mm) | 6"-18" (150mm-450mm) | 269 lbs. (122kg) |

1930 Replacement Hydraulic Pump 22 lbs. (48.5kg)



HYDRAULIC PUMP FLUID

(WHEELER-REX Hydraulic Cutter guarantees valid only when Hydroyl fluid is used.)

3801 1 Qt 2.5 lbs. (1kg)
 3804 1 Gal. 8 lbs. (4kg)

Gallons are available in cases of six.

PIPE CUTTER CHAINS 490 RATCHET, 590 MANUAL & 1790 JR. HYDRAULIC

| Part No. | | Length | No. of pins | Weight |
|---|---|---------|-------------|------------------|
| 522 | Chain for 6" Pipe | 26 1/4" | 21 | 5 lbs. (2.3kg) |
| 532 | Chain for 6" Pipe with rollers for No-Hub® | 26 1/4" | 21 | 5 lbs. (2.3kg) |
| 528 | Chain for 8" Pipe | 36" | 29 | 6.5 lbs. (2.9kg) |
| 533 | Chain for 8" Pipe with rollers for No-Hub® | 36" | 29 | 6.5 lbs. (2.9kg) |
| 5210 | Chain for 10" Pipe | 43 3/4" | 35 | 8 lbs. (3.6kg) |
| 5212 | Chain for 12" Pipe | 51" | 41 | 10 lbs. (4.5kg) |
| 5215 | Chain for 15" Pipe | 58 1/2" | 47 | 11 lbs. (5kg) |
| FOR CONVERTING YOUR PRESENT CHAIN TO CUT LARGER SIZES | | | | |
| 5256 | 6" to 8", 8" to 10", 10" to 12", 12" to 15" | 10" | 8 | 2 lbs. (0.9kg) |
| 5258 | 6" to 10", 8" to 12", 10" to 15" | 17 1/2" | 14 | 3.5 lbs. (1.6kg) |
| 52510 | 6" to 12", 8" to 15" | 25" | 20 | 8 lbs. (3.6kg) |
| 52512 | 6" to 15" | 32 1/2" | 26 | 6 lbs. (2.7kg) |
| 519 | Kit to convert 590 Cutter to 591 No-Hub® Cutter or 490 Cutter to 491 No-Hub® Cutter | | | |

3990 RATCHET PIPE CUTTER

| Part No. | | Length | No. of Pins | Weight |
|----------|-------------------|--------|-------------|------------------|
| 700987 | Chain for 6" Pipe | 26" | 21 | 7 lbs. (3kg) |
| 701077 | Chain for 8" Pipe | 36" | 29 | 8.5 lbs. (3.8kg) |

2990 HYDRAULIC CUTTER

| Part No. | | Length | No. of pins | Weight |
|--|--------------------------------------|---------|-------------|-----------------|
| 1926 | Chain for 6" Pipe | 26 1/4" | 21 | 7 lbs. (3kg) |
| 1924 | Chain for 8" Pipe (replaces 2924) | 36 1/4" | 29 | 10 lbs. (4.5kg) |
| 192410 | Chain for 10" Pipe (replaces 292410) | 46 1/4" | 37 | 12 lbs. (5.5kg) |
| 192412 | Chain for 12" Pipe (replaces 292412) | 53 1/4" | 43 | 14 lbs. (6.5kg) |
| 192415 | Chain for 15" Pipe (replaces 292415) | 61 1/4" | 49 | 16 lbs. (7kg) |
| FOR CONVERTING YOUR PRESENT CHAIN TO CUT LARGER SIZES (Note – Old and new style chain extensions NOT interchangeable) | | | | |
| 19010 | 8" Cutter to 10" | 10" | 8 | 2.5 lbs. (1kg) |
| 19012 | 8" Cutter to 12" | 17 1/2" | 14 | 4.5 lbs. (2kg) |
| 19015 | 8" Cutter to 15" | 25" | 20 | 6.5 lbs (2.9kg) |
| 2905 | Adjusting link for 2990 Chain | | | |

3890 HEAVY DUTY HYDRAULIC CUTTER

| Part No. | | Length | No. of pins | Weight |
|---|--------------------|---------|-------------|------------------|
| 3824 | Chain for 12" Pipe | 50 3/4" | 29 | 25 lbs. (11kg) |
| 382415 | Chain for 15" Pipe | 63" | 37 | 32 lbs. (14.5kg) |
| 382418 | Chain for 18" Pipe | 76 1/2" | 43 | 37 lbs. (16.8kg) |
| 382424 | Chain for 24" Pipe | 97 1/2" | 55 | 47 lbs. (21.4kg) |
| FOR CONVERTING YOUR PRESENT CHAIN TO CUT LARGER SIZES | | | | |
| 382515 | 12" Cutter to 15" | 14" | 8 | 7 lbs. (3kg) |
| 382518 | 12" Cutter to 18" | 24 1/2" | 14 | 11 lbs. (5kg) |
| 382520 | 12" Cutter to 20" | 35" | 20 | 11 lbs. (5kg) |
| 382524 | 12" Cutter to 24" | 46 1/2" | 26 | 22 lbs. (10kg) |

5590 SUPER HYDRAULIC CUTTER

| Part No. | | Length | No. of pins | Weight |
|---|--------------------|---------|-------------|-------------------|
| 5524 | Chain for 18" Pipe | 72 1/2" | 29 | 71 lbs. (32kg) |
| 552420 | Chain for 20" Pipe | 82 1/2" | 33 | 83 lbs. (37.8kg) |
| 552424 | Chain for 24" Pipe | 97" | 39 | 98 lbs. (44.5kg) |
| 552436 | Chain for 36" Pipe | 142" | 57 | 142 lbs. (64.5kg) |
| FOR CONVERTING YOUR PRESENT CHAIN TO CUT LARGER SIZES | | | | |
| 552520 | 18" Cutter to 20" | 10" | 4 | 10 lbs. (4.5kg) |
| 552524 | 18" Cutter to 24" | 25" | 10 | 25 lbs. (11.4kg) |
| 552536 | 18" Cutter to 36" | 70" | 28 | 64 lbs. (29.1kg) |

NOTE: Hydraulic cutter chain parts: individual pins, links and wheels are only available with factory installation. Hydraulic cutter chain extensions are available only through authorized service stations unless installed by the factory.



INTERNAL CAST IRON PIPE CUTTER (CAPITOL STYLE CUTTER)

Cuts Cast Iron from the inside out!!

Designed to eliminate the difficulty plumbers have in setting toilet bowls, urinals and similar fixtures due to the shortness of the closet horn. Make cuts where nothing else can!

| | | |
|-------|-------------------|-------------------|
| 32900 | 3" Cast Iron..... | 10 lbs. (4.5kg) |
| 42900 | 4" Cast Iron..... | 10.5 lbs. (4.7kg) |

Replacement Cutter Wheels:

| | |
|--------|-------------------------------------|
| 700201 | Cutter Wheel for CI for 32900/42900 |
| 276097 | Cutter Wheel Pin |



STEEL PIPE CUTTERS

Two models designed for fast, easy cutting of steel pipes. Both models come with an extra long shank which protects adjustment threads and an extra large handle for quick, easy adjustment.

| | | |
|------|--|----------------|
| 2690 | For 1/8"-2" steel pipe (3.17mm-50.8mm) | 6 lbs. (2.8kg) |
| 8001 | Cutter Wheel for steel | |
| 8082 | Cutter Wheel for stainless steel | |
| 4690 | For 2"-4" steel pipe (50.8mm-101.6mm) | 18 lbs. (8kg) |
| 8004 | Replacement Cutter Wheel | |



HINGED PIPE CUTTER

Four-wheel cutter, featuring a unique guide bar design that ensures both smooth operation and accurate precise pipe cutting. Needs only 90° to 110° handle swing, and only 4 inch clearance. Universal cutter wheels are ideal for cutting most metals and are interchangeable with many other makes of hinged pipe cutters.

| | | |
|-------|--|-----------------|
| 5090 | 1/2"-2" pipe capacity (12.7mm-50.8mm)..... | 6 lbs. (2.7kg) |
| 95240 | 2"-4" pipe capacity (50.8mm-101.6mm)..... | 18 lbs. (8.2kg) |
| 95460 | 4"-6" pipe capacity (101.6mm-152.4mm) | 21 lbs. (9.5kg) |
| 95680 | 6"-8" pipe capacity (152.4mm-203.2mm) | 27 lbs. (12kg) |
| 95121 | 8"-12" pipe capacity (203.2mm-304.8mm) | 35 lbs. (16kg) |

Replacement Cutter Wheels:

| | |
|------|---|
| 8039 | for 5090 for steel |
| 8050 | for 95041, 95240 for steel |
| 8052 | for 95061, 95460 for steel |
| 8054 | for 95081, 95680, 95121 for steel |
| 8051 | for 95041, 95240 for CI/DI |
| 8053 | for 95061, 95081, 95460, 95680, 95121 for CI/DI |
| 8076 | for 95061, 95081, 95460, 95680, 95121 / universal wheel |



PIPEMASTER

General Information:

Unit consists of a cutting head with internal gears which operate the drive wheels and blade shaft. Cutting blades (except for No. 4616) must be cooled with water during cutting and are fully enclosed for safety. The cutter is held onto the pipe by a wide roller chain which is tensioned with a threaded take-up mechanism. A chart is included which tells the operator how much chain is required for various sizes of pipe. PipeMaster comes standard with cutting head, roller chain, wedges and water supply tank in a wood case. Blades are chosen based on pipe material and are not included with the basic machine. Maximum wall thickness for cutting is 1". The unit has a hydraulic motor which requires an external hydraulic power source. See our Model 6500 Power Pak and 701185 Bypass Valve on the next page.

5624 PipeMaster 6" to 24" (150–600mm)104 lbs. (47kg)

PipeMaster Features:

- Maximum hydraulic requirements 6 gpm/1500 psi
- Gearbox: Worm Drive with 80–90W gear oil required
- Cutting speed: 3" (150mm) of surface travel per minute
1" (25mm) of diameter per minute
- Cutting Clearance: Radial 8" (200mm); Axial 16" (400mm)
- Blade Speed: 1200 RPM
- Construction: Aluminum gearbox, side plated steel; bronze gears, steel roller chain, drive wheels are aluminum with urethane covering

PIPEMASTER ACCESSORIES

- 700821 20' Hydraulic Hose Assembly complete with male/female FF quick disconnects
 276288 Flat Face Male Quick Disconnect
 276289 Flat Face Female Quick Disconnect

Standard equipment (comes with 5624):

- 700970 Two Drive Wheels for 6" pipe *These drive wheels are required to cut 6" pipes
 276693 Water Supply Tank, 4 gallon
 4685 Set of 6 steel wedges
 4686 Roller Chain, one link section

Number of Chain Links Required:

| | |
|-----------------|-------------|
| Pipe Diameter | 24" (600mm) |
| Number of Links | 34 pieces |





6500 HYDRAULIC POWER PAK221 lbs. (100.5kg)

Features:

- Maximum hydraulic information: 6 gpm/1500 psi
- Adjustable pressure-relief valve
- Complete with 6.5 hp. Honda engine, on two-wheeled cart with pneumatic tires and cage
- Comes with two 700821 – 20' Hydraulic Hose Assemblies complete with male/female FF quick disconnects
- Can be used to power other hydraulic tools



701185 BYPASS VALVE KIT

Bypass Valve 6 gpm/1500 psi13 lbs. (5.9kg)

Bypass Valve Kit is designed to be used with your truck, skid loader, backhoe or tractor's hydraulic system for use with the WHEELER-REX PipeMaster. The 701185 will adapt your current hydraulic system to the specs required to operate the PipeMaster (maximum 6 gpm/1500 psi). Weight is only 10 pounds and it is easy to connect. The PipeMaster's hydraulic lines will directly attach to the quick disconnects for both input and output points on the Bypass Valve. Hydraulic lines are required and are not included with the 701185 and are available as an additional accessory.*

*700821 20' Hydraulic Hose Assembly complete with male/female FF quick disconnects

Features:

- Maximum input from alternative hydraulic power source: 0–30 gpm/0–3000psi
- Maximum output from Bypass valve: 0–6 gpm/0–1500psi



Blade No. 4706
6" Carbide-tipped
Blade for Steel Pipe



Blade No. 4606
6" Diamond Blade for
CI/DI Pipe

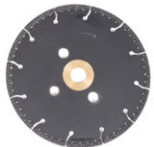

Blade No. 4616
6" Economy Diamond
Blade for DI Pipe

PIPEMASTER BLADES

Three blades for Cast Iron, Ductile Iron and Steel Pipes. Available with diamond or carbide tipped. These blades will fit the WHEELER-REX PipeMaster as well as Universal and Utility Cutters from Reed Manufacturing, Keel and WACHS.

4706 6" Carbide Tipped Blade for steel pipes

4606 6" Diamond Blade for cast iron, ductile iron and clay pipes

4616 6" Economy Diamond Blade for ductile iron pipes. Cut dry or wet. Low price and excellent performance make this blade the best value on the market!

PLASTIC PIPE & COPPER TUBE TOOLS

GLASS TUBE CUTTERS

For cutting glass tube and pipe as well as other brittle tubular materials. These tools are based on the original Wheeler "Squeeze and Pop" principle employing cutter wheels in the chain.



69012

For 1/4" thru 3/4" (6-18mm) O.D. gauge glass, laboratory glass, and porcelain tube. Small enough to carry in your pocket and almost as simple to use as a pair of pliers. Just wrap the chain around the tube, and hook the nearest chain pin in the jaw. Then a quick twist of the wrist, a slight squeeze of the handles, and pop!

Weight 1 lb. (0.45 kg)



79014

For 1/4" thru 1" (6-25mm) O.D. gauge glass, laboratory glass, and porcelain tube. Small enough to carry in your pocket and almost as simple to use as a pair of pliers. Just wrap the chain around the tube and insert it through the jaw. Then a quick twist of the wrist, a slight squeeze on the handles, and pop!

Weight 1 lb. (0.45 kg)



79022

For 1/4" thru 1 1/2" (6-37mm) O.D. gauge glass, laboratory glass, and porcelain tube. Similar to the model 79014 except with a longer chain. Small enough to carry in your pocket and simple to use. Just wrap the chain around the tube and insert it through the jaw. Then a quick twist of the wrist, a slight squeeze on the handles, and pop!

Weight 1 lb. (0.45 kg)



REPLACEMENT GLASS CUTTER CHAIN

| Part | Description | Length | No. of Pins |
|--------|---------------------------------------|----------------|-------------|
| 690012 | Complete Chain for 69012 Glass Cutter | 3" (75mm) | 12 |
| 7914 | Complete Chain for 79014 Glass Cutter | 5 1/2" (137mm) | 14 |
| 7922 | Complete Chain for 79022 Glass Cutter | 8" (200mm) | 22 |

PROFESSIONAL SNIPPERS

WHEELER-REX Professional Snippers have been proven with years of professional use to be the snippers to have in your tool box. Durable and of high quality, with strong construction and long blade life, they are a must!



5190 SNIPPER

For 1/8" to 1 1/4" (3-31mm) O.D. soft plastic tubing and hose.

Weight 0.7 lb. (0.3kg)

5200 Replacement Blade

Blades are reversible for double life. Handles are die-cast aluminum — NOT plastic.



5191 WITH COATED BLADE

For 1/8" to 1 1/4" (3-31mm) O.D. soft plastic tubing and hose, and 1/2" and 3/4" (12-19mm) 160 lb. and 200 lb. PVC.

Weight 0.7 lb. (0.3kg)

5299 Replacement Blade

Blades are reversible for double life. Handles are die-cast aluminum — NOT plastic.



5291 RATCHET ACTION

For 1/8" to 1 5/8" (3-42mm) O.D. Schedule 40 Materials: PVC, ABS, vinyl, poly pipe and tubing. Ratchet style.

Weight 1 lb. (0.5kg)

5300 Replacement Blade



7291 RATCHET ACTION

For 1/8" to 2 7/16" (3-63mm) O.D. Schedule 40 Materials: Polyethylene, Polybutylene, Polypropylene, vinyl, PVC, and ABS pipe and tubing. Ratchet style. One hand operation.

Weight 1.25 lbs. (0.56kg)

7324 Replacement Blade

PROFESSIONAL V-BLADE SNIPPERS



5280 RATCHET ACTION

For 1/8" to 1 5/8" (3-42mm) O.D. Schedule 40 Materials: PVC, ABS, vinyl, poly pipe and tubing, and PEX.

Weight 1 lb. (0.5kg)

5350 Replacement Blade



7280 RATCHET ACTION

For 1/8" to 2 7/16" (3-63mm) O.D. Schedule 40 Materials: PVC, ABS, vinyl, poly pipe and tubing, and PEX.

Weight 1.25 lb. (0.56 kg)

7350 Replacement Blade

ECONOMY SNIPPERS

Need a snipper, but only for the occasional job? WHEELER-REX has an economical way for you to do just that and not spend a lot of money!



4190 MICRO SNIPPER

For 1/4" to 3/8" (6-9mm) O.D. soft plastic tubing and hose.

Weight 0.15 lb. (0.07kg)

Great for PVC supply lines!



5195 ECONOMY SNIPPER

For 1/8" to 1 1/4" (3-31mm) O.D. soft plastic tubing and hose.

Weight 0.7 lb. (0.3kg)

5196 Replacement Blade



5295 ECONOMY RATCHET ACTION

For 1/8" to 1 5/8" O.D. (3-41mm) Schedule 40 Materials: PVC, ABS, vinyl, poly pipe and tubing. Easy to use, anti-rust, anti-wear construction with a heat treated blade.

Weight 1 lb. (0.45kg)

5296 Replacement Blade





HAND SAWS

Two sizes with comfort fit handles: for plastic pipe and miscellaneous materials. **CUTS ON PUSH AND PULL STROKE.**

- 600** 18" long blade (37mm).
Capacity: 1/2" to 6" (12-150mm) Sold in cartons of six or individually
With PTFE coated blade: 18" long (37mm).
- 601** 13" long blade (25mm).
Capacity: 1/2" to 6" (12-150mm) Sold in cartons of six or individually
With PTFE coated blade: 13" long (25mm).
- 602** 13" long blade (25mm).
Capacity: 1/2" to 3" (12-75mm) Sold in cartons of six or individually
With PTFE coated blade: 13" long (25mm).
- 603** 13" long blade (25mm).
Capacity: 1/2" to 3" (12-75mm) Sold in cartons of six or individually
With PTFE coated blade: 13" long (25mm).

Replacement Blades:

- 610** Replacement Blade for 600 Hand Saw sold in cartons of twelve or individually
Weight for carton 6 lbs. (2.7kg)
- 611** Replacement Blade for 601 Hand Saw sold in cartons of twelve or individually
Weight for carton 6 lbs. (2.7kg)
- 612** Replacement Blade for 600 Hand Saw sold in cartons of twelve or individually
Weight for carton 4 lbs. (1.8kg)
- 613** Replacement Blade for 603 Hand Saw sold in cartons of twelve or individually
Weight for carton 4 lbs. (1.8kg)

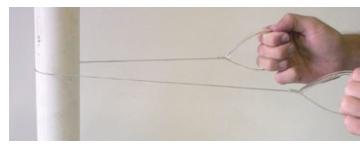

PVC AND ABS CABLE SAW

Cut PVC and ABS in tight places where other methods will not work. Simply slip the cable saw around the pipe and see-saw to quickly make a cut. Available in two lengths.

- 626** 26" Cable Saw 0.05lb.
- 636** 36" Cable Saw 0.05lb.



9015 HAND OPERATED PLASTIC PIPE BEVELER

The Universal Plastic Pipe Beveler makes a 15° bevel on SDR35 and Sch 40 thermoplastic pipe through 12" (300mm) capacity. It is lightweight and easy to adjust to different wall thicknesses for beveling and deburring. **Wide saddle won't twist and dig into the pipe like others.**

- Capacity: 1 1/2" through 12" (38-300mm) Diameter
- Weight 5 lbs. (2.3kg)
- 220083** Replacement Bevel Blade



POWER OPERATED PLASTIC PIPE BEVELER

The power bevelers are designed for a wide variety of situations including high production applications. Our advanced HSS cutter design makes a smooth 15° bevel, which is adjustable for length and depth. Tools are easy to use and drastically reduces beveling time, especially on large pipe sizes or when doing production beveling.

- 9000** Capacity: 4" (100mm) and up. 115V, 1 3/4 hp., 11.0 amp motor, 24,500 RPM..... 15 lbs. (6.8kg)
- 9001** Model 9000 with Carbide Bit..... 15 lbs. (6.8kg)
- 220220** Beveler Unit less router (Includes 220234)
- 220234** Replacement HSS 15° Router Bit Assembly with 3/8" Shank and 1/2" Collet
- 220041** Replacement Carbide 15° Router Bit Assembly with 3/8" Shank and 1/2" Collet



PLASTIC PIPE & COPPER TUBE TOOLS

CONTINUED



PIPE HOG® PVC / ABS FITTING REAMER

Quickly and accurately bores out solvent welded fittings to make repairs. Fits 1/2" drill chuck. Saves time and material. Pays for itself in one use.

| | | |
|-------|--|-----------|
| 16150 | 1 1/2" Pipe Hog for Schedule 40..... | 0.73 lbs. |
| 16200 | 2" Pipe Hog for Schedule 40..... | 0.9 lbs. |
| 16300 | 3" Pipe Hog for Schedule 40..... | 1.2 lbs. |
| 16400 | 4" Pipe Hog for Schedule 40..... | 1.8 lbs. |
| 16010 | Pipe Hog Kit with extension shaft..... | 6 lbs. |

Accessories:

| | |
|--------------------|-----------------------------|
| 700588 | Schedule 80 Guide for 16150 |
| 700589 | Schedule 80 Guide for 16200 |
| 700590 | Schedule 80 Guide for 16300 |
| 700591 | Schedule 80 Guide for 16400 |
| 16050 | 12" Extension Shaft |
| 16055 | 1/2" Square Carbide Insert |
| Pat. No. 3,752,593 | |



FITTING SAVER

Quickly and easily removes pipe from solvent welded fittings. Fits 3/8" drill chuck. Saves time and money over replacing whole assemblies. Perfect for plumbing, irrigation and sprinkler contractors.

Fitting Savers for Schedule 40

| | | |
|-------|---|-----------|
| 19050 | 1/2" IPS Fitting Saver..... | 0.45 lbs. |
| 19075 | 3/4" IPS Fitting Saver..... | 0.5 lbs. |
| 19100 | 1" IPS Fitting Saver..... | 0.6 lbs. |
| 19020 | Sch 40 Fitting Saver Kit (contains 19050, 19075, 19100 Fitting Savers in case)..... | 1.8 lbs. |

Fitting Savers for Schedule 80

| | | |
|-------|---|-----------|
| 19051 | 1/2" IPS Fitting Saver..... | 0.45 lbs. |
| 19076 | 3/4" IPS Fitting Saver..... | 0.5 lbs. |
| 19101 | 1" IPS Fitting Saver..... | 0.6 lbs. |
| 19025 | Sch 80 Fitting Saver Kit (contains 19051, 19076, 19101 Fitting Savers in case)..... | 1.8 lbs. |

| | | |
|--------|-----------------------------|-----------|
| 19030 | 1/2" CTS Fitting Saver..... | 0.45 lbs. |
| 19035 | 3/4" CTS Fitting Saver..... | 0.45 lbs. |
| 277228 | Carbide Cutting Insert | |
| 277227 | Screw for Insert | |



BEFORE



Insert tool into broken or cut pipe



Begin cutting pipe

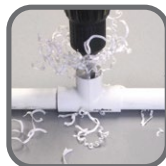

Continue until proper depth is obtained



AFTER



INTERNAL PLASTIC PIPE CUTTERS

Make accurate, square cuts at floor level or in other blind locations. Cutters are easily preset for depth of cut and make their cuts in seconds. Recommended user supplied power source: 1/2" capacity, 350-450 RPM drill, rated at 4.6 to 6 amps.

For PVC and ABS plastic pipe. For individual pipe sizes from 1 1/2" to 6" Diameter.

| | | | |
|------|--------------------------------------|--------------|-----------|
| 1590 | For 1 1/2" Schedule 40 pipe and DWV. | Weight | 1 lbs. |
| 2290 | For 2" Schedule 40 pipe and DWV. | Weight | 1.5 lbs. |
| 2492 | For 2" Schedule 80 pipe and DWV. | Weight | 1.4 lbs. |
| 3290 | For 3" Schedule 40 pipe and DWV. | Weight | 1.9 lbs. |
| 3490 | For 3" Schedule 80 pipe and DWV. | Weight | 1.85 lbs. |
| 4290 | For 4" Schedule 40 pipe and DWV. | Weight | 2.6 lbs. |
| 4490 | For 4" Schedule 80 pipe and DWV. | Weight | 2.45 lbs. |
| 6000 | For 6" Schedule 40 pipe and DWV. | Weight | 4.2 lbs. |
| 6154 | Kit for 1 1/2", 2", 3", 4" | Weight | 12 lbs. |
| 6156 | Kit for 1 1/2", 2", 3", 4", 6" | Weight | 14 lbs. |

Replacement Blades:

| | |
|--------|--|
| 1293 | Replacement Blade for Models 1590, 2290 and 2492 |
| 3293 | Replacement Blade for Models 3290 and 3490 |
| 4293 | Replacement Blade for Models 4290, 4490 and 6000 |
| 32964 | 4' Drive Shaft for 1 1/2" - 2" models |
| 700777 | 6' Drive Shaft for 1 1/2" - 2" models |
| 700778 | 6' Drive Shaft for 3", 4" and 6" models |

Replacement Blades:

| Model | Adjustable Cutting Depth Range |
|-------------|--------------------------------|
| 1590 & 2290 | 1 5/8" - 8 1/4" |
| 3290 & 3490 | 1 5/8" - 8 1/4" |
| 4290 & 4490 | 1 5/8" - 11 5/8" |
| 6000 | 2 3/8" - 12 3/4" |



POLY PIPE CHAMFERING TOOL / DEPTH GAUGE

Lightly bevels the end of polyethylene pipe prior to socket fusion. The tool is sized to allow marking for the proper end distance for the cold ring per ASTM F1056.

| | | |
|-------|-----------------|-----------|
| 10050 | 1/2" CTS..... | 0.35 lbs. |
| 10075 | 3/4" CTS..... | 0.40 lbs. |
| 10100 | 1" CTS..... | 0.45 lbs. |
| 10125 | 1 1/4" CTS..... | 0.50 lbs. |
| 10150 | 1 1/2" CTS..... | 0.60 lbs. |
| 10200 | 2" CTS..... | 0.85 lbs. |
| 30050 | 1/2" IPS..... | 0.40 lbs. |
| 30075 | 3/4" IPS..... | 0.50 lbs. |
| 30100 | 1" IPS..... | 0.45 lbs. |
| 30125 | 1 1/4" IPS..... | 0.60 lbs. |
| 30150 | 1 1/2" IPS..... | 0.55 lbs. |
| 30200 | 2" IPS..... | 0.70 lbs. |

700155 Replacement Blade for All Models



GUILLOTINE PIPE CUTTERS

892

Designed to cut water/sewer plastic pipe up to 4.0" (125mm) O.D. Comes standard with removable T-Handle design, which can be removed to expose a 1" Hex nut. Wide saddle side-swing opening design simplifies positioning at any point on pipe. This nut can also be driven with a ratchet and 1" socket.

Weight.....18 lbs. (8kg)

701149 Replacement V-Shaped Blade PTFE Coated

700692 Replacement Straight Blade PTFE Coated

6515 Ratchet

506032 Socket

1697

Designed to cut thin-walled water/sewer plastic pipe up to 8.0" (225mm) O.D. Comes standard with removable T-Handle design, which can be removed to expose a 1" Hex nut. This nut can also be driven with a ratchet and 1" socket.

Weight.....46 lbs. (18kg)

701358 Stainless Steel V-Blade

6515 Ratchet

506032 Socket



1698

Designed to cut thin-walled water/sewer, NDPE and HDPE plastic pipe up to 8.0" (225mm) O.D. Comes standard with removable T-Handle design, which can be removed to expose a 1" Hex nut. This nut can also be driven with a ratchet and 1" socket.

Weight.....46 lbs. (18kg)

701567 Low-profile Pointed Blade

1894

A unique approach to cutting large diameter water/sewer plastic pipes. Can be used with a low speed power drive (300-500 RPM maximum), that delivers power to the blade through a right angle worm drive. Power cutting at 300 RPM is a fast 1 minute per inch of pipe diameter and gives better cuts and longer blade life due to reduced flexing. Maximum cutting capacity of 13.2" (335mm) O.D.

Power source is not included.

Weight95 lbs. (43kg)

701454 Stainless Steel V-Blade

1897

A unique approach to cutting large diameter water/sewer plastic pipes. Comes standard with removable T-Handle design, which can be removed to expose a 1" Hex nut. This nut can also be driven with a ratchet and 1" socket. Maximum cutting capacity of 13.2" (335mm) O.D.

Weight.....102 lbs. (46.2kg)

701454 Stainless Steel V-Blade

6515 Ratchet

506032 Socket

Ratchet
(optional)



Power Driven
(1894 only)



T-Handle
(standard with 892,
1697, 1897 & 1698)



Guillotine Style Pipe Cutter Features:

- HDPE/MDPE with low-profile pointed blade * Thin-walled plastic pipe with v-shaped blade
- Coated steel cutter blade creates outstanding ease of cutting and corrosion protection
- Wide saddle side-swing opening design simplifies positioning at any point on pipe
- Wide saddle base provides sturdy, positive pipe support
- Stainless steel fasteners and hardware
- Structural members produced from aircraft-grade aluminum
- Dry-lube coated drive screw

CRIMPING TOOLS

WHEELER-REX introduces a line of crimping tools specifically designed to help install better connections on PEX potable water or radiant heating systems. The full circle crimp eliminates the unsightly appearance of tool marks and distortion of crimped rings.



89202 1/2" PEX RING CRIMPER

A PEX Ring Crimper for 1/2". Crimps conform to ASTM specifications and is supplied with a go/no-go gauge. Complete with a soft, comfortable grip. OAL 12"

Weight4 lbs. (1.8kg)



89203 3/4" PEX RING CRIMPER

A PEX Ring Crimper for 3/4". Crimps conform to ASTM specifications and is supplied with a go/no-go gauge. Complete with a soft, comfortable grip. OAL 12"

Weight4 lbs. (1.8kg)



89204 1" PEX RING CRIMPER

A PEX Ring Crimper for 1". Crimps conform to ASTM specifications and is supplied with a go/no-go gauge. Complete with a soft, comfortable grip and long handles for extra leverage. OAL 19"

Weight6 lbs. (2.7kg)



89206 1/2" AND 3/4" PEX COMBO CRIMPER

A Combination Pex Ring Crimper for 1/2" and 3/4". Crimps conform to ASTM specifications and is supplied with a go / no-go gauge. Complete with a soft, comfortable grip and long handles for extra leverage. OAL 16"

Weight5.4 lbs. (2.5kg)



STAINLESS CLAMP PINCHER RATCHET TOOL

The PEX Stainless Clamp Pincher Ratchet Tool with a full cycle mechanism assures consistent water tight crimps, eliminating the need for a crimp gauge. Made from heat treated steel for strength and durability. Its compact design and lightweight frame allow this tool to be extremely versatile when used in confined areas.

Our PEX Stainless Clamp Pincher ratchet tool can be used for 3/8", 1/2", 3/4" and 1". Crimps conform to ASTM F2098 specifications. OAL 11"

89250 Stainless Clamp Pincher, weight..... 2 lb. (0.9kg)



PEX RING REMOVER

This unique tool is designed for fitting recovery without damaging the fittings. The high mechanical advantage makes shearing of rings much easier and faster than sawing off a crimped ring. Just two cuts on the ring allow the user to reclaim the fitting. Saves time and money!

89210 1/2"-1" Ring Remover, weight1.2 lbs. (0.54kg)
892100 Replacement Cutting Blade



CLOSE QUARTERS CRIMP TOOLS

A unique tool designed for 1/2" and 3/4" pipe sizes. These tools provide a toggle action, which helps to assure a complete crimp cycle. Lightweight with a comfort fit handle, its high mechanical action allows one hand crimping to ASTM specifications. OAL 12"

- 89215 1/2" Close Quarters Crimp Tool 3.2 lbs. (1.45kg)
- 89216 3/4" Close Quarters Crimp Tool 3.2 lbs. (1.45kg)



89217 CLAMP CRIMPER

The Close Quarters Tool crimps rings to ASTM F-1087 on 3/8", 1/2", 3/4", and 1" pipe. A wrench is used to torque the bolts down until the gap is eliminated. Convenient 1" and 3/4" on one side, flip over and 1/2" and 3/8" on the reverse. Complete with a gauge to assure crimps are to specifications. OAL 3 1/2"

Weight..... 1.5 lbs. (0.68kg)



89211 CLAMP REMOVAL TOOL

This unique tool allows fitting recovery with an effortless torquing action. Apply the socket to a "T" bar or socket wrench and place over the pinched clamp. By turning 90 degrees in a clockwise action and then counter-clockwise the clamp is sheared making fitting recovery quick and easy. Remove all clamps 3/8", 1/2", 5/8", 3/4" and 1" with ONE tool. Wrench nut supplied.

Weight..... 1 lb. (0.5kg)



RETRACTABLE UTILITY KNIFE

Featuring a curved, comfort design, internal blade storage, interlock system and toolless blade changing.

- 5741 Retractable Utility Knife Weight 0.4 lbs (0.2kg)
- 5761 5 Pack of Replacement Blades



SELF-RETRACTING UTILITY KNIFE

Featuring a curved, comfort design, internal blade storage, interlock system and toolless blade changing.

- 5751 Retractable Utility Knife Weight 0.4 lbs (0.2kg)
- 5761 5 Pack of Replacement Blades



MINI TUBING CUTTERS

For accurate cutting of copper, brass and aluminum tubing.

- 90721 For 1/8" to 1" (3-25mm) O.D..... 0.3 lbs. (0.15 kg)
- 90727 For 1/8" to 1 1/8" (3-30mm) O.D. 0.5 lbs. (0.22 kg)
- 8069 Replacement Cutter Wheel



TELESCOPIC TUBING CUTTER

For accurate cutting of copper, brass and aluminum tubing. Telescopic cutter wheel feeding system keeps turning radius constant. Includes spare wheel. Swivel deburring tool retracts conveniently into the body.

- 90734 For 1/8" to 1 3/8" (3-35mm) O.D..... 0.8 lbs. (0.35 kg)
- 8069 Replacement Cutter Wheel
- 80711 Replacement Deburring Blade



TUBING CUTTER

Cuts copper, aluminum and thin wall material. Grooved roller allows for close to the flare cut. No tool required for fast wheel change. Ergonomic knob.

- 90710 For 1/8" to 1 1/8" (3-30mm) O.D..... 0.8 lbs. (0.35kg)
- 8069 Replacement Cutter Wheel



QUICK RELEASE TUBING CUTTER

Gives clean square cuts on copper, brass, aluminum tubing and thin walled conduit. Changing the cutter wheel allows plastic pipe to be cut. Tool includes two cutter wheels and swivel deburring tool which is stored conveniently in the body of the cutter.

- 90747 For 1/4" to 3" (6-76mm) O.D..... 2 lbs. (.9kg)
- 8069 Replacement Cutter Wheel
- 8068 Replacement Cutter Wheel for Plastic
- 80711 Replacement Deburring Blade



QUICK RELEASE TUBING CUTTER

Gives clean, square cuts on plastic and non-ferrous metal pipe. Spring loaded cutter wheel feeding system allows slide-action size adjustment and quick release.

- 90748 For 2" to 5" (50–127mm) O.D. 4 lbs. (1.65kg)
- 8066 Replacement Cutter Wheel for plastic
- 8067 Replacement Cutter Wheel for non-ferrous metals
- 90749 For 4" to 6 5/8" (100–168mm) O.D. 4 lbs. (1.8kg)
- 8066 Replacement Cutter Wheel for plastic
- 8067 Replacement Cutter Wheel for non-ferrous metals



STAINLESS STEEL TUBING CUTTERS

Specially designed for cutting stainless steel. All three models have a steel feed screw system and use specially designed cutter wheels with needle bearings for durability and longevity. No tools are required to change the cutter wheel and wheel pin.

- 90724 1/8" to 1 1/8" (3–30mm) O.D. Mini Tubing Cutter 0.5 lbs. (0.22kg)
- 90730 1/8" to 1 3/4" (3–44.5mm) O.D. Tubing Cutter 0.9 lbs. (0.41kg)
- 90764 1/4" to 3" (6.35–76.2mm) O.D. Tubing Cutter 2 lbs. (0.9kg)
- 90799 Replacement Cutter Wheel



450 COPPER TUBE CLEANER

Cleans inside and outside 1/2" and 3/4" copper tubing. Leaves copper surface polished and cleaned for optimum solder flow. Replaceable high carbon steel bristles extend tool life beyond that of disposable brushes.

- Weight 1 lb. (0.5kg)
- 452 Four Piece Replacement Brush Set



4506 6-IN-1 COPPER TUBE CLEANER

Cleans inside and out plus deburrs the inside diameter of 1/2" and 3/4" tubing with hardened steel reamer/deburrer.

- Weight 1 lb. (0.5kg)
- 452 Four Piece Replacement Brush Set



4992 CLOSE QUARTERS TUBING CUTTER

Designed for plumbing remodeling, commercial boiler and air conditioning jobs, where standard cutters simply don't have the room. Cuts thin-wall material like traps and tailpieces with no distortion. Featuring a small swing radius of 3 - 5/8", it's perfect for under vanities, waste and overflows, and close to walls. Eliminates sawing which can loosen joints. Cutter comes with cutter wheel (No. 8038 for non-ferrous materials. Also available is cutter wheel (No. 8033 to cut plastic). For 1/4" to 2 3/8" (6-59mm) O.D. non-ferrous tube and plastic pipe and tube.

| | | |
|--------|--------------------------------------|------------------|
| Weight | | 1.5 lbs. (0.7kg) |
| 8038 | Replacement Cutter Wheel for Copper | |
| 8033 | Replacement Cutter Wheel for Plastic | |

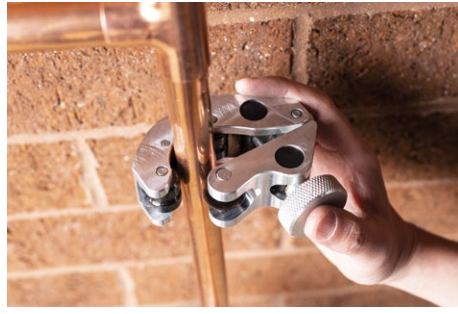

AUTO-C TUBING CUTTERS

With it's C-shape, these cutters are easy to grip and do not require any swing space. Just turn the cutter in the direction of the arrow and the cut will be complete in seconds. The spring loaded cutter wheel self-feeds with consistent pressure. Cuts type-K, L and M copper and CTS CPVC.

| | | |
|------|----------------------------------|------------------|
| 5690 | Auto-C Cutter 1/2" (15.9mm)..... | 0.5 lb. (0.23kg) |
| 5691 | Auto-C Cutter 3/4" (22.2mm)..... | 0.5 lb. (0.23kg) |
| 5692 | Auto-C Cutter 1" (28.6mm)..... | 0.5 lb. (0.23kg) |
| 8046 | Replacement Cutter Wheel | |



RATCH CUT TUBE AND PIPE CUTTERS

3590 RATCH CUT WITH METAL HANDLE

Uniquely designed for fast, accurate pipe cutting, especially in confined, nearly inaccessible locations. Suitable for use on mild or stainless steel, copper or thinwall PVC and CPVC tubing from 1/8" to 3/8" (3-9mm).

| | | |
|--------|--------------------------|-------------------|
| Weight | | 0.5 lbs. (0.23kg) |
| 8040 | Replacement Cutter Wheel | |



3790 RATCH CUT WITH METAL HANDLE

A larger version of our Model 3590 cutter described above. Use it for quick, precise cutting of mild or stainless steel, copper or thinwall PVC and CPVC tubing from 5/16" to 1 1/8" (8-27mm).

| | | |
|--------|--|-------------------|
| Weight | | 1.5 lbs. (0.68kg) |
| 8041 | Replacement Cutter Wheel | |
| 8044 | Cutter Wheel for thin walled stainless steel | |



INNER & OUTER REAMER

For fast, clean, inner and outer reaming and outer deburring/beveling of 3/8"-2" copper and stainless steel tubing. Made of hardened steel construction.

50100 Inner/Outer Reamer 3/8"-2" (10mm-54mm) 1 lbs. (0.46 kg)



DEBURRING TOOL

Ideal for removing internal burrs in copper, plastic, aluminum and steel tubing. Features long lasting replaceable high speed steel blade and plastic handle with built-in pocket clip.

919 5 Pack of Deburring Tools 0.15 lbs. (0.06 kg)
 921 10 Pack of Deburring Tools 0.6 oz. (0.17 kg)
 925 50 Pack of Deburring Tools 1.45 oz. (0.65 kg)
 80711 Replacement HSS Blade



4700 HAMMERHEAD FLARING TOOL

Four interchangeable heads flare 3/4"-2" type-K copper pipe. The 6 lb. slide hammer is easier and safer than regular hammers and the pressure-relieving heads allow flaring with water in the line. Complete with custom carrying case.

Weight18 lbs. (8kg)



4900 REROUNDING TOOL KIT

WHEELER-REX Rerounding Tools quickly and easily reround soft type-K copper tubing for proper seal when using compression fittings. For safety, use only with brass hammers. For 3/4" through 2" copper pipe, compact, divided kit makes transport easy.

Weight12 lbs. (5.4kg)

49075 3/4" Rerounding Tool*1 lbs. (0.45kg)
 49100 1" Rerounding Tool*1.6 lbs. (0.7kg)
 49150 1 1/2" Rerounding Tool*2.7 lbs. (1.2kg)
 49200 2" Rerounding Tool*5.5 lbs. (2.5kg)

* Included in 4900 Tool Kit

REPLACEMENT CUTTER WHEELS

| WHEELER-REX | | RIDGID® | | REED® | |
|-------------------------------|---|------------------------|---|------------------------|-----------------------------------|
| METAL TUBING CUTTERS | | | | | |
| CUTTER WHEEL MODEL NO. | TUBING CUTTER MODEL NO. | CUTTER WHEEL MODEL NO. | TUBING CUTTER MODEL NO. | CUTTER WHEEL MODEL NO. | TUBING CUTTER MODEL NO. |
| 8012 | 9290, 9291 | E1240 | 10, 15, 20 | OSS | TC1Q, TC1.6Q, TC2Q, T10, T15, T20 |
| 8015 | 9290, 9291 | F158 | 10, 15, 20 | 0 | TC1Q, TC1.6Q, TC2Q, T10, T15, T20 |
| 8021 | | E2191 | 30, 40, 106, 108, 109, 122, 133, 134, 136, 154, 156 | 30-40 | TC3Q, TC4Q, TC5Q, TC6Q, TC8Q |
| 8025 | 9490 | E2558 | 30, 40, 106, 108, 109, 133, 134, 136, 154, 156 | 30-40 | TC3Q, TC4Q, TC5Q, TC6Q, TC8Q |
| 8034 | | E3469 | 101, 103, 104, 105, 117, 118, 131, 132, 150, 151, 152, 153, 205 | 345T | MC2 |
| 8038 | 4992, 4991, 4990 | | | | |
| 8040 | 2590, 3590 | | | | |
| 8041 | 3790 | | | | |
| 8044 (SS) | 3790 | | | | |
| 8045 | 90722 | E4546 | 105, 131, 132, 150 - 153, 205 | R4546 | MC2 |
| 8046 | 5690, 5691, 5692 | | | SLRCW | TC50SL, TC75SL, TC1SL |
| 8067 | 90748, 90749 | E2558 | 30, 40, 106, 108, 109, 133, 134, 136, 154, 156 | 30-40 | TC3Q, TC4Q, TC5Q, TC6Q, TC8Q |
| 8069 | 90710, 90721, 90727, 90734, 90747 | F158 | 10, 15, 20 | 0 | TC1Q, TC1.6Q, TC2Q, T10, T15, T20 |
| 8071 | 90735, 90728, 90750 | | | 73505 | TC14, TC166, MC3 |
| 90799 (SS) | 90724, 90730, 90764 | | | | |
| PLASTIC TUBING CUTTERS | | | | | |
| 8033 | 4992 | | | | |
| 8037 | | E2156, E5299, E2157 | | 3-6PVC | TC3Q, TC4Q, TC5Q, TC6Q |
| 8066 | 90748, 90749 | | 30P, 40P, 133P, 134P, 136P, 154P, 156P, 106, 109P | 80P | TC6Q, TC8Q |
| 8068 | 90747 | | | | |
| 8073 | 90750 | | | OP2 | TC1Q, TC1.6Q, TC2Q, T10, T15, T20 |
| 8074 | 90751 | | | | |
| 8075 | 90752 | | | | |
| PIPE CUTTERS | | | | | |
| 8001 | 2690 (Steel) | F514, M-50, F3, F3S | 1, 2, 42, 300, 50, 1A, 2A, 42A, 201, 202 | 2RBHD | 2-1, 2-1Q, 2-4WG, 2-3, 2-3Q, 2-4 |
| 8003 | | E1032 | 300, 535, 1822-1, MACH | HX2, 1/2 | |
| 8004 | 4690 (Steel) | FS229S | | | |
| 8006 | | F367 | 6S, 208, 209 | R367 | |
| 8039 | 5090 | | | | |
| 8082 | 2690 (SS) | | | | |
| 700201 | 32900, 42900 | | | | |
| HINGED CUTTERS | | | | | |
| 8050 | 95041, 95240 | | | HS4 | H4 |
| 8051 | 95041, 95240 | | | HS4 | H4 |
| 8052 | 95061, 95460 | | | HS6 | H6 |
| 8053 | 95061, 95081, 95121, 95460, 95680 | | | HI6 | H6, H8, H12 |
| 8054 | 95081, 95121, 95680 | | | HS8-12 | H8, H12 |
| 8076 | 95061, 95081, 95121, 95460, 95680 | | | H6PSE5 | H6, H8, H12 |
| THREADING MACHINES | | | | | |
| 60322 | WHEELER-REX MODELS 6990, 6991, 7991, 8991 | | | | |
| 60324 | WHEELER-REX MODELS 7890, 6090, 7090, 8090, 6190, 6290, 6390, 6490, 6790 | | | | |
| 60390 | CUTTER BLADE FOR 6794 & 6590 | | | | |
| 60310 | HSS CUTTER WHEEL FOR 6790, 6793 | | | | |
| 60301 | HSS CUT-OFF BLADE FOR 6794 & 6590 | | | | |

RIDGID IS A REGISTERED TRADEMARK OF THE RIDGE TOOL CO.
 REED IS A REGISTERED TRADEMARK OF THE REED MFG. CO.

GROOVING & FABRICATION



PORTABLE ROLL GROOVERS

For 1"-6" Schedule 5 to Schedule 40 steel. T-handle feed design minimizes operator fatigue. No separate ratchet required. SAFER – short lengths of pipe stay on rollers without operator assistance. All models are lightweight, compact and easily mounted. Carriage does not need to be removed for installation.

| | | | |
|------|--|---------|----------|
| 8400 | 2"-6" Roll Groover with Base for 6090, 7090 & 8090 | 33 lbs. | (15kg) |
| 8401 | 2"-6" Roll Groover with Base for Model 300..... | 33 lbs. | (15kg) |
| 8402 | 2"-6" Roll Groover with Base for Model 300 Compact | 34 lbs. | (15.5kg) |
| 8403 | 2"-6" Roll Groover with Base for 6790 | 35 lbs. | (15.9kg) |

Accessories:

| | |
|--------|---|
| 84000 | Base Only for Models 6090, 7090 & 8090 Machines |
| 84001 | Base Only for Model 300 Machines |
| 84002 | Base Only for Model 300 Compact Machines |
| 84003 | Base Only for Model 6790 Machines |
| 700628 | 2"-6" Roller & Shaft Set for Copper Pipe |
| 700639 | 1" Roller & Shaft Set for Steel |
| 700640 | 1 1/4"-1 1/2" Roller & Shaft Set for Steel |

HYDRAULIC ROLL GROOVER

For use with a pipe threading machine. Makes grooves 1"-16" Schedule 10 and 1"-12" Schedule 40. Conveniently and easily attaches to your 2" or 4" pipe threading machine. The carriage, reamer or die heads do not need to be removed from the machine. A simple mounting bracket provides quick attachment to WHEELER-REX 6090, 7090, 8090 and 6790 Threading Machines as well as Model 300 Machines.

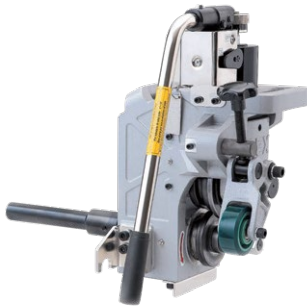

| | | | |
|------|--|---------|----------|
| 9700 | Hydraulic Roll Groover with Base for WHEELER-REX 6090, 7090 & 8090 | 94 lbs. | (42.7kg) |
| 9701 | Hydraulic Roll Groover with Base for WHEELER-REX 6790..... | 94 lbs. | (42.7kg) |
| 9703 | Hydraulic Roll Groover with Base for Model 300 Machines..... | 94 lbs. | (42.7kg) |

Features:

- Compact, light weight, powerful and large capacity
- Built-in hydraulic cylinder
- Easy operation with guide roller to prevent the pipe from slipping and helps to eliminate vibration
- Unit comes standard with 2"-6" Roller Set (341133) for Schedule 40
- Capacity: 1"-16" Schedule 10 Steel (341125 Spacer)
1"-12" Schedule 40 Steel Pipe

HYDRAULIC ROLL GROOVER ACCESSORIES

| | |
|---------|---|
| 341560 | Machine Mounting Kit for WHEELER-REX 6090,7090 & 8090 |
| 341562 | Machine Mounting Kit for WHEELER-REX 6790 |
| 341563 | Machine Mounting Kit for Model 300 Machines |
| 341118 | Roller Set 1"- 1 1/2" Sch 5 and 10, Thin-Wall SS |
| 341119 | Roller Set 2"- 3" Sch 5 and 10, Thin-Wall SS |
| 341120 | Roller Set 4"- 6" Sch 5 and 10, Thin-Wall SS |
| 606460 | Roller Set 1"- 1 1/2" Sch 10-40 |
| 606520• | Roller Set 2"- 6" Sch 10-40 |
| 606459 | Roller Set 8"- 12", 8" Sch 40 / 8"-12" Sch 10-30 |
| 341137 | Roller Set 10"- 12" Sch 40 |
| 341138 | Roller Set 14"- 16" Sch 10 |
| 341141 | Shaft 1"- 1 1/2" |
| 341124 | Guide/Gauge for 8" to 12" |
| • | Included with basic machine. |



9700 Hydraulic Roll Groover on Threader.



HYDRAULIC ROLL GROOVING MACHINES

Produces factory grooves on 1"-12" Schedule 10 and 1"-8" Schedule 40 steel pipe. Unique features include horizontal self-centering head, finished groove indicator light and optional electric power pump. Two (2) 220V outlets required; one (1) for the motor and one (1) for the hydraulic system. Standard rollers included for 2"-6".

Specifications: 220V 50-60Hz ONLY

Standard Accessories: 2"-6" rollers, toolbox and tools.

| | | | | |
|------|--|----------------------|----------|---------|
| 7702 | 2"-6" with manual pump 50-60Hz Only | Weight, packed | 272 lbs. | (124kg) |
| 7703 | 2"-6" with electric power pump 50Hz Only | Weight, packed | 262 lbs. | (119kg) |

Optional Accessories:

- 341118 Roller Set 1"-1 1/2" Sch 5 & Sch 10, Thin Wall SS
 - 341119 Roller Set 2"-3" Sch 5 & Sch 10, Thin Wall SS
 - 341120 Roller Set 4"-6" Sch 5 & Sch 10, Thin Wall SS
 - 606460•• Roller Set 1"-1 1/2" Sch 10-40
 - 606520• Roller Set 2"-6" Sch 10-40
 - 606459 Roller Set 8"-12", 8" Sch 40 / 8"-12" Sch 10-30
 - 341137 Roller Set 10"-12" Sch 40
 - 341136 Roller Set 14"-16" Sch 10
 - 606461•• Shaft 1"-1 1/2"
- Included with basic machine.
 - Both items are required to groove 1" - 1 1/2" pipe



Support stand not included.

ORBITAL PIPE CUTTER

For 4"-12" (100-300mm) steel and ductile iron pipe. The clamshell frame and modular design make this machine fast and easy to set up and operate. A single frame and gear plate make the orbital the most economical unit for its size range. Standard 115V electric power. Complete with all necessary accessories and packed in a storage case.

| | | |
|------|--|------------------|
| 6412 | Cut & Bevel, DI & CI pipe 4"-12" (100-300mm) | |
| 8412 | Cut & Bevel, steel pipe 4"-12" (100-300mm) | |
| 5412 | Cut & Groove, steel pipe 4"-12" (100-300mm) | |
| | Weight | 362 lbs. (165kg) |

Spares and Accessories:

| | |
|--------|--|
| 220267 | Cut-Off Blade, DI |
| 220808 | RH Cut-Off Blade, steel |
| 220809 | LH Cut-Off Blade, steel |
| 220705 | 30° Steel Bevel Blade |
| 220706 | 37 1/2° Steel Bevel Blade |
| 220770 | 45° Steel Bevel Blade |
| 220707 | 45° DI Bevel Blade |
| 220855 | Support Stand (not included with orbital as standard feature—purchased separately) |

MANTIS™ REPLACEMENT BLADES

| Blade Number | Material | Number of Teeth |
|--------------|--------------------------|-----------------|
| 475200 | Alloy | 8 |
| 475201 | | 10 |
| 475202 | | 14 |
| 475203 | | 18 |
| 475204 | | 24 |
| 475210 | High-Speed Steel Bimetal | 10 |
| 475211 | | 14 |
| 475212 | | 18 |
| 475213 | | 24 |

PIPE THREADING

MANUAL RATCHET THREADER SETS

WHEELER-REX Drop Heads and Dies are ideal for in-place threading from 1/2" - 2" and are designed to fit Wheeler Ratchet Handle 43310 as well as the Ridge Tool Company Models 12R, OO-R, 111-R, O-R, 30A & 31A, 600 & 700 Power Drives, Reed Mfg. DHR12 Series Drop Heads and Berkley Tool BT40000 Series Drop Heads.



| | | | |
|-------|---|----------|----------|
| 4200 | Complete with Tool Box for 1/2"-2" | 52 lbs. | (23.6kg) |
| 4202 | Complete with Tool Box for 1/2"-1" | 27 lbs. | (12kg) |
| 4207 | Complete with Tool Box for 1/2"-1 1/4" | 39 lbs. | (18kg) |
| 4211 | Complete with Tool Box for 1"-2" | 42 lbs. | (19kg) |
| 4213 | Complete without Tool Box for 1/2"-2" | 35 lbs. | (16kg) |
| 4215 | Complete with Tool Box for 1/2"-2" BSPT | 49 lbs. | (22kg) |
| 43310 | Ratchet Handle..... | 5.5 lbs. | (2.5kg) |
| 43300 | Replacement Carrying Case..... | 14 lbs. | (6kg) |



HAND OPERATED OILER

The WHEELER-REX hand operated oiler features a metal reservoir bucket, removable plastic scrap/chip tray and 56" hose with trigger nozzle. Includes one gallon of ThreadMaster Oil.

| | | | |
|-------|-----------------------|---------|---------|
| 5900 | Weight..... | 19 lbs. | (8.6kg) |
| 59050 | Replacement Hand Pump | | |

MINI POWER DRIVES

Lightweight and portable, the WHEELER-REX Mini Power Drive can thread up to 1 1/4" diameter pipe or conduit and 1" bolt or rod in just seconds. Accepts 12R style die heads. Requires only 1 3/4" clearance for working in trenches, overhead and in tight quarters and can tighten nuts, drive cable pullers, turn hoists and jacks, open and close valves. Mechanical high speed reverse speeds removal after threading.



| | | | |
|-----|---|---------|--------|
| 640 | Power Drive, 12R Adapter & Safety Vise with Case..... | 38 lbs. | (17kg) |
|-----|---|---------|--------|

Accessories:

| | | | |
|------|-------------------------|---------|-------|
| 6401 | Case only for 640 | 13 lbs. | (6kg) |
| 6402 | 12R Adapter for 640 | | |

Safety Vise:

| | | | |
|-------|---|--------|-------|
| 80115 | Absorbs torque from Power Drives to reduce fatigue and protect the operator | 6 lbs. | (3kg) |
|-------|---|--------|-------|

12R STYLE DIES - NPT

| Wheeler # | Ridge # | Nominal Pipe Size | Type Thread | Die Material |
|-----------|---------|-------------------|-------------|--------------|
| 837825 | 37825 | 1/2" | NPT | Alloy |
| 837830 | 37830 | 3/4" | NPT | Alloy |
| 837835 | 37835 | 1" | NPT | Alloy |
| 837840 | 37840 | 1 1/4" | NPT | Alloy |
| 837845 | 37845 | 1 1/2" | NPT | Alloy |
| 837850 | 37850 | 2" | NPT | Alloy |

12R STYLE DROP HEAD WITH DIES - NPT

| Wheeler # | Ridge # | Nominal Pipe Size | Type Thread | Die Material |
|-----------|---------|-------------------|-------------|--------------|
| 837390 | 37390 | 1/2" | NPT | Alloy |
| 837395 | 37395 | 3/4" | NPT | Alloy |
| 837400 | 37400 | 1" | NPT | Alloy |
| 837405 | 37405 | 1 1/4" | NPT | Alloy |
| 837410 | 37410 | 1 1/2" | NPT | Alloy |
| 837415 | 37415 | 2" | NPT | Alloy |

12R STYLE DIES - BSPT

| Wheeler # | Ridge # | Nominal Pipe Size | Type Thread | Die Material |
|-----------|---------|-------------------|-------------|--------------|
| 866125 | 66125 | 1/2" | BSPT | Alloy |
| 866130 | 66130 | 3/4" | BSPT | Alloy |
| 866135 | 66135 | 1" | BSPT | Alloy |
| 866140 | 66140 | 1 1/4" | BSPT | Alloy |
| 866145 | 66145 | 1 1/2" | BSPT | Alloy |
| 866150 | 66150 | 2" | BSPT | Alloy |

12R STYLE DROP HEAD WITH DIES - BSPT

| Wheeler # | Ridge # | Nominal Pipe Size | Type Thread | Die Material |
|-----------|---------|-------------------|-------------|--------------|
| 865965 | 65965 | 1/2" | BSPT | Alloy |
| 865970 | 65970 | 3/4" | BSPT | Alloy |
| 865975 | 65975 | 1" | BSPT | Alloy |
| 865980 | 65980 | 1 1/4" | BSPT | Alloy |
| 865985 | 65985 | 1 1/2" | BSPT | Alloy |
| 865990 | 65990 | 2" | BSPT | Alloy |



8991 SIDEKICK III PIPE THREADER

The WHEELER-REX Model 8991 is a full-featured threading machine for 1/2" to 1" pipe. Featuring front and rear chucks, an auto-open auto-oiling notch-type die head, safety auto shut off, larger carriage & cutter handles and a unique one blade reamer.

Model 8991 Features:

- Auto open notch die head
- Front and rear chucks
- Auto-oiling die head
- Large scrap tray
- Weighs only 58 pounds
- Safety auto shut off
- One blade reamer
- 1" pipe threading time – 16 seconds
- Built-in carrying handle
- Foot switch
- Spare cutter wheel

Includes:

- 1/2"-1" die head
- Two sets of dies: 1/2"-3/4" and 1"

Specifications:

Standard Capacity: 1/2"-1"
 Voltage: 115 Volt
 Motor: 400 Watt series, single phase
 Free Speed: 55 RPM
 Net Weight: 58 lbs.
 Dimensions: 15" x 11" x 12"

Optional:

- 1/4"-3/8" NPT dies
- 1/4"-1" NPT Die Head
- 841 Stand

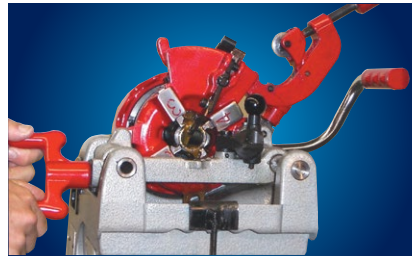

Weight..... 70 lbs. (31.7kg)
 Net weight..... 58 lbs. (26kg)

8992 Same as 8991 except comes complete with 60131 manual opening die head for 1/4"-1". Along with 1/4"-3/8", 1/2"-3/4" and 1" NPT dies.

Weight..... 70 lbs. (31.7kg)
 Net weight..... 58 lbs. (26kg)

8993 Same as 8991 except comes complete with two 1/2"-1" quick opening 70131 die heads and one each 1/2"-3/4" and 1" NPT dies.

Weight..... 78 lbs. (35kg)
 Net weight..... 58 lbs. (26kg)

8998 Same as 8991 except comes complete with 220V motor.

Weight..... 70 lbs. (31.7kg)
 Net weight..... 58 lbs. (26kg)

THREE YEAR WARRANTY, INCLUDING ELECTRIC MOTORS



MODEL 8992 SHOWN ON OPTIONAL 841 STAND





8090

Features complete **interchangeability** with the Model 300 dies and die heads. This portable and compact, high-performance threading machine has a self-opening die head and through the die head oiling. Completely equipped to cut, thread and ream.

Features: For 1/2" to 2" pipe, 110/120V, single phase 700W series motor, average noise level: 85db, maximum amperage under load: 15.3, no load RPM: 39
Includes: 1/2"-2" die head, two sets of NPT dies: 1/2"-3/4" and 1"-2", spare cutter wheel, foot switch, 4 legs.

Weight 186 lbs. (84.5kg)
 Net weight 140 lbs. (64kg)

THREE YEAR WARRANTY, INCLUDING ELECTRIC MOTORS.



8096 Same as 8090 except comes with two 80118 Die Heads.

Weight 200 lbs. (91kg)
 Net weight 140 lbs. (64kg)

THREE YEAR WARRANTY, INCLUDING ELECTRIC MOTORS.

8097 Same as 8090 except comes with 897065 Universal Die Head for 1/8"-2".

Weight, packed 186 lbs. (84.5kg)
 Net weight 140 lbs. (64kg)

THREE YEAR WARRANTY, INCLUDING ELECTRIC MOTORS.

8098 Same as 8090 except comes with 220V motor.

Weight, packed 186 lbs. (84.5kg)
 Net weight 140 lbs. (64kg)

THREE YEAR WARRANTY, INCLUDING ELECTRIC MOTORS.



BALL DETENTS ARE STANDARD ON ALL WHEELER-REX DIE HEADS

UNIVERSAL REPLACEMENT DIES

WHEELER-REX Dies are manufactured from Tool Steel and are designed to fit Wheeler Die Head 897065 as well as the following Ridge Tool Models 504A, 711, 713, 811A, 815A, 816, 817, and 842.

UNIVERSAL DIE HEAD

Wheeler # Ridge #
 897065 97065 For 1/8"-2" Quick opening die head..... 12 lbs. (5.5kg)

PIPE DIES FOR UNIVERSAL DIE HEADS - NPT

| Wheeler # | Ridge # | Nominal Pipe Size | Type Thread | Die Material |
|-----------|---------|-------------------|-------------|--------------|
| 847745 | 47745 | 1/2"-3/4" | NPT | Tool Steel |
| 847750 | 47750 | 1"-2" | NPT | Tool Steel |

PIPE DIES FOR UNIVERSAL DIE HEADS - NPT FOR STAINLESS STEEL

| Wheeler # | Ridge # | Nominal Pipe Size | Type Thread | Die Material |
|-----------|---------|-------------------|-------------|--------------|
| 847785 | 47785 | 1/2"-3/4" | NPT | HSS |
| 847790 | 47790 | 1"-2" | NPT | HSS |





6790

The 6790 features a self-opening die head, with through die head oiling. Ultimate accuracy with quick changes between pipe sizes, producing quality threads. The 6790 offers adjustable thread length, three-stage oil filtration system, and a sturdy three flute reamer that covers the entire 1/2"-4" range. The 6790 is a three speed machine that is powered by a durable condenser motor, with an extremely low noise level. Completely equipped to cut, thread, and ream.

Features: For 1/2" to 4" pipe, 110V/120V or 220V/230V, single phase 1KW condenser motor, average noise level: 72db, maximum amperage under load: 18.5 no load RPM: 15/27/48, 1Hp, 50/60HZ

Includes: Two die heads: 1/2"-2" and 2 1/2"-4", three sets of NPT dies: 1/2"-3/4", 1"-2" and 2 1/2"-4", spare cutter wheel, foot switch, 4 legs and built-in tool tray.

Optional: 1/4"-3/8" NPT, 3/4"-4" beveling and grooving, 5/16"-2" UNC bolt, and 1/2"-4" NPSM
 Weight 409 lbs. (186kg)
 Net weight 326 lbs. (148kg)

THREE YEAR WARRANTY, INCLUDING ELECTRIC MOTORS.



6793 Same as 6790 except with **THREE (3) self-opening NOTCH-TYPE DIE HEADS**. This offers accuracy, quick changes between pipe sizes and eliminates switching dies when changing pipe sizes. Completely equipped to cut, thread, and ream.

Weight 423 lbs. (192kg)
 Net weight 344 lbs. (157kg)

THREE YEAR WARRANTY, INCLUDING ELECTRIC MOTORS.

6794 Same as 6790 except with a **BLADE-TYPE CUTTER**, which is designed for plastic lined pipe, as well as standard steel pipe. Completely equipped to cut, thread, and ream.

Features: For 1/2" to 4" pipe, 110V/120V or 220V/230V, single phase 1KW condenser motor, average noise level: 72db, maximum amperage under load: 18.5 no load RPM: 15/27/48

Includes: Two die heads: 1/2"-2" and 2 1/2"-4", three sets of NPT dies: 1/2"-3/4", 1"-2" and 2 1/2"-4", spare cutter wheel, foot switch, 4 legs and built-in tool tray.

Optional: 1/4"-3/8" NPT, 3/4"-4" beveling and grooving, 5/16"-2" UNC bolt, and 1/2"-4" NPSM
 Weight 406 lbs. (185kg)
 Net weight 334 lbs. (152kg)

THREE YEAR WARRANTY, INCLUDING ELECTRIC MOTORS.



6590

This machine has self opening notch type die heads with through die head oiling. These die heads offer accuracy and quick changes between pipe sizes, while providing quality threads. The 6590 is totally gear driven and powered by a condenser motor, producing extremely low noise levels. Quiet operation permits use in hospitals, factories, and in other locations where noise can be a problem. Completely equipped to cut, thread, and ream.

Features: For 2 1/2" - 6" pipe, 110/120V or 220V/230V, single phase .75KW condenser motor, average noise level: 76db, maximum amperage under load: 14.5, no load RPM: 6.1/20.2, 1Hp, 50/60HZ

Includes: Two die heads: 2 1/2"-4" and 5"-6", two sets of NPT dies: 2 1/2"-4", and 5"-6", foot switch, 4 legs and Blade-Type Cutter.

Optional: 2 1/2" - 6" beveling and grooving
 Weight 532 lbs. (242kg)
 Net weight 451 lbs. (206kg)

THREE YEAR WARRANTY, INCLUDING ELECTRIC MOTORS.





THREADER CARTS

| | | | |
|-------|--|----------|----------|
| 60513 | Collapsible Cart for WHEELER-REX 8090 Pipe Threader..... | 101 lbs. | (46kg) |
| 60518 | Anti-Tip Bracket for Collapsible Carts..... | 13 lbs. | (5.8kg) |
| 60506 | Threader Cart w/out Toolbox for 6390/6790/6794/6793..... | 135 lbs. | (61.4kg) |
| 60507 | Threader Cart with Toolbox for 6390/6790/6794/6793..... | 178 lbs. | (81kg) |
| 60514 | Threader Cart w/out Toolbox for 6590..... | 135 lbs. | (61.4kg) |
| 60515 | Threader Cart with Toolbox for 6590..... | 178 lbs. | (81kg) |



NIPPLE ATTACHMENTS

| | | | |
|-------|------------------------------|----------|---------|
| 62000 | 1/2" NPT Nipple Chuck..... | 3 lbs. | (1.4kg) |
| 62001 | 3/4" NPT Nipple Chuck..... | 3 lbs. | (1.4kg) |
| 62002 | 1" NPT Nipple Chuck..... | 3 lbs. | (1.4kg) |
| 62003 | 1 1/4" NPT Nipple Chuck..... | 5 lbs. | (2.3kg) |
| 62004 | 1 1/2" NPT Nipple Chuck..... | 5 lbs. | (2.3kg) |
| 62005 | 2" NPT Nipple Chuck..... | 5.5 lbs. | (2.5kg) |
| 62006 | 2 1/2" NPT Nipple Chuck..... | 8 lbs. | (3.6kg) |
| 62007 | 3" NPT Nipple Chuck..... | 8.5 lbs. | (3.8kg) |
| 62009 | 4" NPT Nipple Chuck..... | 12 lbs. | (5.5kg) |



841 PORTABLE THREADER STAND

Light weight folding stand. Designed to fit model 7991/8991.....30 lbs. (14kg)



WHEELER-REX PIPE THREADING OIL

WHEELER-REX Pipe Threading Oil gives you premium performance at a reasonable price. Blended to thread Stainless Steel, Galvanized as well as Carbon Steel means you only need one oil for all your needs. Low odor and transparent appearance make this fluid pleasant to use in addition to creating quality threads and long die life.

| | | | |
|-------|--|----------|-----------|
| 60601 | 1 Gallon ThreadMaster Oil..... | 8 lbs. | (3.5kg) |
| 60604 | 1 Quart ThreadMaster Oil..... | 2.5 lbs. | (1kg) |
| 60603 | 2 Quart ThreadMaster Oil..... | 4.5 lbs. | (2kg) |
| 60602 | 5 Gallon Pail of ThreadMaster Oil..... | 41 lbs. | (19kg) |
| 60655 | 55 Gallon Drum of ThreadMaster Oil..... | 434 lbs. | (197kg) |
| 60607 | 1 Gallon ThreadMaster Oil for Stainless Steel..... | 12 lbs. | (5.4kg) |
| 60608 | 5 Gallon Pail of ThreadMaster Oil for Stainless Steel..... | 42 lbs. | (19.05kg) |

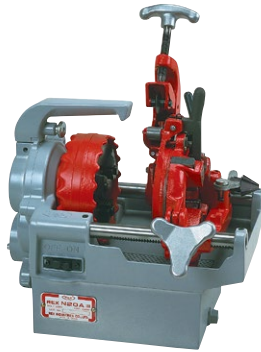

6990 PONY 1/4"-3/4" MAXIMUM PIPE RANGE

| PART NO. | | DIES |
|----------|--|-------------|
| 60210 | 1/4"-3/8" NPT (60131 Die Head) | |
| 60211• | 1/2"-3/4" NPT (60130 Die Head) | |
| | | DIE HEADS |
| 60130• | 1/2"-3/4" NPT/Self Opening Notch Style | |
| | | SPARE PARTS |
| 60322• | Cutter Wheel | |
| 600979 | Chuck Jaw Insert Set | |
| 602005 | Motor Brush Set | |
| 602029 | Reamer Cone | |

- Included with basic machine.



6991 SIDEKICK 1/4"-1" MAXIMUM PIPE RANGE

| PART NO. | | DIES |
|----------|---|-------------|
| 60210 | 1/4"-3/8" NPT (60131 Die Head) | |
| 60211• | 1/2"-3/4" NPT (60130 & 60131 Die Heads) | |
| 60212• | 1" NPT (60131 Die Head) | |
| 60256 | 1/2"-3/4" NPSM (60131 Die Head) | |
| 60257 | 1" NPSM (60131 Die Head) | |
| | | DIE HEADS |
| 60131• | 1/4"-1" NPT/Manual Opening | |
| | | SPARE PARTS |
| 60322• | Cutter Wheel | |
| 602103 | Chuck Jaw Insert Set | |
| 602005 | Motor Brush Set | |
| 602125 | Reamer Cone | |

- Included with basic machine.

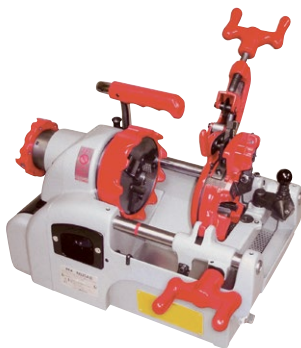

7991 SIDEKICK II AND 8991 SIDEKICK III 1/4"-1" MAXIMUM PIPE RANGE

| PART | | DIES |
|--------|---|-------------|
| 60210 | 1/4"-3/8" NPT Dies (60131 Die Head) | |
| 60211• | 1/2"-3/4" NPT Dies (60130, 60131 & 70131 Die Heads) | |
| 60212• | 1" NPT Dies (60131 & 70131 Die Heads) | |
| 60213 | 1/4"-3/8" NPT Dies for S.S. (60131 Die Head) | |
| 60214 | 1/2"-3/4" NPT Dies for S.S. (60131 & 70131 Die Heads) | |
| 60215 | 1" NPT Dies for S.S. (60131 & 70131 Die Heads) | |
| 60256 | 1/2"-3/4" NPSM Dies (60131 & 70131 Die Heads) | |
| 60257 | 1" NPSM Dies (60131 & 70131 Die Heads) | |
| | | DIE HEADS |
| 70131• | 1/2"-1" NPT/Auto-Open, Notch Type Die Head | |
| 60131 | 1/4"-1" NPT/Manual Opening Die Head | |
| 60136 | 1/4"-3/8" NPT/Auto-Open Die Head | |
| | | SPARE PARTS |
| 60322• | Cutter Wheel | |
| 62322 | Cutter Wheel for Stainless Steel | |
| 602103 | Chuck Jaw Insert Set | |
| 606665 | Motor Brush Set | |
| 606705 | Reamer Blade | |

- Included with basic machine.

Model 6890 was discontinued 11/1/06 and these parts are interchangeable with Model 7890.

7890 1/4"-1 1/2" MAXIMUM PIPE RANGE



| PART NO. | DIES |
|-------------|---|
| 60200 | 1/4"-3/8" NPT (60120 Die Head) |
| 60201 • | 1/2"-3/4" NPT (60120 Die Head) |
| 60202 • | 1"-1 1/2" NPT (60120 Die Head) |
| 60220 | 1/4"-3/8" HSS NPT (60120 Die Head) |
| 60346 | 5/16"-18 UNC Bolt (60125 Die Head) |
| 60347 | 3/8"-16 UNC Bolt (60125 Die Head) |
| 60348 | 7/16"-14 UNC Bolt (60125 Die Head) |
| 60340 | 1/2"-13 UNC Bolt (60125 Die Head) |
| 60341 | 5/8"-11 UNC Bolt (60125 Die Head) |
| 60342 | 3/4"-10 UNC Bolt (60125 Die Head) |
| 60343 | 7/8"-9 UNC Bolt (60125 Die Head) |
| 60344 | 1"-8 UNC Bolt (60125 Die Head) |
| 60345 | 1 1/8"-1 1/4" 7 UNC Bolt (60125 Die Head) |
| 60349 | 1 1/2"-6 UNC Bolt (60125 Die Head) |
| DIE HEADS | |
| 60120 • | 1/4"-1 1/2" NPT/Manual Opening |
| 60125 | 5/16"-1 1/2" UNC Bolt/Manual Opening |
| SPARE PARTS | |
| 60324 • | Cutter Wheel |
| 60323 | Chuck Jaw Insert Set |

- Included with basic machine.

7090 & 8090 1/8"-2" MAXIMUM PIPE RANGE



8090
Threading
Machine



80118 Die Head

| PART NO. | DIES |
|-------------|--|
| 70201 • | 1/2"-3/4" NPT (70118, 80118 & 897065 Die Heads) |
| 70209 • | 1"-2" NPT (70118, 80118 & 897065 Die Heads) |
| 847745 | 1/2"-3/4" NPT (70118, 80118 & 897065 Die Heads) |
| 847750 | 1"-2" NPT (70118, 80118 & 897065 Die Heads) |
| 847785 | 1/2"-3/4" S.S. (70118, 80118 & 897065 Die Heads) |
| 847790 | 1"-2" S.S. (70118, 80118 & 897065 Die Heads) |
| DIE HEADS | |
| 80118# | 1/2"-2" NPT/Automatic Opening Die Head for 8090 |
| 897065 | 1/8"-2" NPT/Quick Opening Die Head |
| SPARE PARTS | |
| 60324 • | Cutter Wheel |
| 70235 | Chuck Jaw Insert Set |
| 60513 | Collapsible Threader Cart for 8090 |

- Included with 8090 basic machine.

6090 1/4"-2" MAXIMUM PIPE RANGE



| PART NO. | DIES |
|----------|--|
| 60200 | 1/4"-3/8" NPT (60115 Die Head) |
| 60201 • | 1/2"-3/4" NPT (60118 Die Head) |
| 60209 • | 1"-2" NPT (60118 Die Head) |
| 60220 | 1/4"-3/8" HSS NPT (60115 Die Head) |
| 60233 | 1/2"-3/4" S.S. (60118 Die Head) |
| 60238 | 1"-2" S.S. (60118 Die Head) |
| 60250 | 1/2"-3/4" NPT for PVC (60118 Die Head) |
| 60251 | 1"-2" NPT for PVC (60118 Die Head) |
| 60353 | 3/4" Beveling 37.5° (60117 Die Head) |
| 60354 | 1"-2" Beveling 37.5° (60117 Die Head) |
| 60338 | 3/4" Grooving (60117 Die Head) |
| 60339 | 1"-2" Grooving (60117 Die Head) |
| 60230 | 1/2"-3/4" Conduit (60116 Die Head) |
| 60231 | 1"-1 1/4" Conduit (60116 Die Head) |
| 60232 | 1 1/2"-2" Conduit (60116 Die Head) |
| 60346 | 5/16"-18 UNC Bolt (60114 Die Head) |
| 60347 | 3/8"-16 UNC Bolt (60114 Die Head) |
| 60348 | 7/16"-14 UNC Bolt (60114 Die Head) |
| 60340 | 1/2"-13 UNC Bolt (60114 Die Head) |
| 60341 | 5/8"-11 UNC Bolt (60114 Die Head) |

- Included with basic machine.



6090 1/4"-2" MAXIMUM PIPE RANGE CONTINUED

| | |
|-----------------------------|---|
| 60342 | 3/4"-10 UNC Bolt (60114 Die Head) |
| 60343 | 7/8"-9 UNC Bolt (60114 Die Head) |
| 60344 | 1"-8 UNC Bolt (60114 Die Head) |
| 60345 | 1 1/8" & 1 1/4" - 7 UNC Bolt (60114 Die Head) |
| 60349 | 1 1/2"-6 UNC Bolt (60114 Die Head) |
| 60352 | 2"-4 1/2" UNC Bolt (60114 Die Head) |
| 60360 | 3/4" Beveling Dies for SS (60117 Die Head) |
| 60361 | 1"-2" Beveling Dies for SS (60117 Die Head) |
| 60362 | 3/4" Grooving Dies for SS (60117 Die Head) |
| 60363 | 1"-2" Grooving Dies for SS (60117 Die Head) |
| DIE HEADS | |
| 60115 | 1/4"-2" NPT/Manual Opening |
| 60118• | 1/2"-2" NPT/Automatic Opening |
| 60114 | 5/16"-2" UNC Bolt/Manual Opening |
| 60117 | 3/4"-2" Beveling & Grooving |
| 60112 | 1/2"-3/4" NPT/Automatic Opening,/Notch type |
| 60113 | 1"-2" NPT/Automatic Opening,/Notch type |
| 60116 | 1/2"-2" Conduit/Manual Opening |
| SPARE PARTS AND CART | |
| 60324• | Cutter Wheel |
| 60318 | Chuck Jaw Insert Set |
| 60328 | Chuck Jaw Insert Set for Plastic Coated Pipe |
| 60509 | Collapsible Threader Cart |

- Included with basic machine.

6390 1/4"-2" MAXIMUM PIPE RANGE

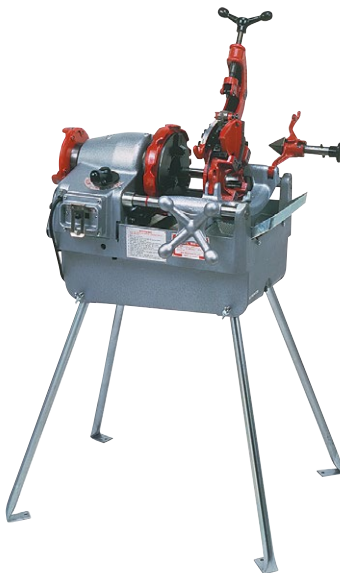

| PART NO. | DIES |
|-----------------------------|---|
| 60200 | 1/4"-3/8" NPT (60115 Die Head.) |
| 60201• | 1/2"-3/4" NPT (60112 & 60115 Die Heads) |
| 60220 | 1/4"-3/8" HSS NPT (60115 Die Head) |
| 60233 | 1/2"-3/4" S.S. (60112 & 60115 Die Heads) |
| 60208• | 1"-2" NPT (60113 Die Head) |
| 60234 | 1"-2" S.S. (60113 Die Head) |
| 60250 | 1/2"-3/4" NPT for PVC (60112 & 60115 Die Heads) |
| 60252 | 1"-2" NPT for PVC (60113 Die Head) |
| 60353 | 3/4" Beveling 37.5° (60117 Die Head) |
| 60354 | 1"-2" Beveling 37.5° (60117 Die Head) |
| 60338 | 3/4" Grooving (60117 Die Head) |
| 60339 | 1"-2" Grooving (60117 Die Head) |
| 60230 | 1/2"-3/4" Conduit (60116 Die Head) |
| 60231 | 1"-1 1/4" Conduit (60116 Die Head) |
| 60232 | 1 1/2"-2" Conduit (60116 Die Head) |
| 60346 | 5/8"-18 UNC Bolt (60114 Die Head) |
| 60347 | 3/8"-16 UNC Bolt (60114 Die Head) |
| 60348 | 7/16"-14 UNC Bolt (60114 Die Head) |
| 60340 | 1/2"-13 UNC Bolt (60114 Die Head) |
| 60341 | 5/8"-11 UNC Bolt (60114 Die Head) |
| 60342 | 3/4"-10 UNC Bolt (60114 Die Head) |
| 60343 | 7/8"-9 UNC Bolt (60114 Die Head) |
| 60344 | 1"-8 UNC Bolt (60114 Die Head) |
| 60345 | 1 1/8" & 1 1/4"-7 UNC Bolt (60114 Die Head) |
| 60349 | 1 1/2"-6 UNC Bolt (60114 Die Head) |
| 60352 | 2"-4 1/2" UNC Bolt (60114 Die Head) |
| DIE HEADS | |
| 60112• | 1/2"-3/4" NPT/Automatic Opening/Notch type |
| 60113• | 1"-2" NPT/Automatic Opening/Notch type |
| 60114 | 5/16"-2" UNC Bolt/Manual Open |
| 60115 | 1/4"-2" NPT/Manual Opening |
| 60117 | 3/4"-2" Beveling & Grooving |
| 60116 | 1/2"-2" Conduit/Manual Opening |
| SPARE PARTS AND CART | |
| 60324• | Cutter Wheel |
| 60306 | Chuck Jaw Insert Set for black iron and PVC pipes |
| 60506 | Threader Cart NO Toolbox |
| 60507 | Threader Cart with Toolbox |

- Included with basic machine.

6790, 6793 & 6794 1/4"-4" MAXIMUM PIPE RANGE



| PART NO. | DIES |
|----------------------|--|
| 60200 | 1/4"-3/8" NPT (60115 Die Head) |
| 60201●●● | 1/2"-3/4" NPT (60112, 60115 & 60118 Die Heads) |
| 60233 | 1/2"-3/4" S.S. (60112, 60115 & 60118 Die Heads) |
| 60250 | 1/2" - 3/4" NPT for PVC (60112, 60115 & 60118 Die Heads) |
| 60209●●● | 1"-2" NPT (60118 & 6 0115 Die Heads) |
| 60208●●● | 1"-2" NPT (60113 Die Head) |
| 60234 | 1"-2" S.S. Dies (60113 Die Head) |
| 60238 | 1"-2" S.S. (60118 & 60115 Die Heads) |
| 60251 | 1" - 2" NPT for PVC (60118 & 60115 Die Heads) |
| 60206●●● | 2 1/2"-4" Taper or Straight Threads (60106 Die Head) |
| 60252 | 1" - 2" NPT for PVC (60113 Die Head) |
| 60235 | 2 1/2"-4" S.S. (60106 Die Head) |
| 60253 | 2 1/2" - 4" NPT for PVC (60106 Die Head) |
| 60353 | 3/4" Beveling 37.5° (60117 Die Head) |
| 60354 | 1"-2" Beveling 37.5° (60117 Die Head) |
| 60330 | 2 1/2"-4" Beveling 37.5° (60123 Die Head) |
| 60332 | 2 1/2"-4" S.S. Beveling 37.5° (60123 Die Head) |
| 60338 | 3/4" Grooving (60117 Die Head) |
| 60339 | 1"-2" Grooving (60117 Die Head) |
| 60227 | 2 1/2"-3 1/2" Grooving (60123 Die Head) |
| 60228 | 4" Grooving (60123 Die Head) |
| 60357 | 2 1/2"-3 1/2" Grooving Dies for S.S. (60123 Die Head) |
| 60358 | 4" Grooving Dies for S.S. (60123 Die Head) |
| 60346 | 5/16"-18 UNC Bolt (60114 Die Head) |
| 60347 | 3/8"-16 UNC Bolt (60114 Die Head) |
| 60348 | 7/16"-14 UNC Bolt (60114 Die Head) |
| 60340 | 1/2"-13 UNC Bolt (60114 Die Head) |
| 60341 | 5/8"-11 UNC Bolt (60114 Die Head) |
| 60342 | 3/4"-10 UNC Bolt (60114 Die Head) |
| 60343 | 7/8"-9 UNC Bolt (60114 Die Head) |
| 60344 | 1"-8 UNC Bolt (60114 Die Head) |
| 60345 | 1 1/8"-1 1/4"-7 UNC Bolt (60114 Die Head) |
| 60349 | 1 1/2"-6 UNC Bolt (60114 Die Head) |
| 60352 | 2"-4 1/2 UNC Bolt (60114 Die Head) |
| 60230 | 1/2"-3/4" Conduit (60116 Die Head) |
| 60231 | 1"-1 1/4" Conduit (60116 Die Head) |
| 60232 | 1 1/2"-2" Conduit (60116 Die Head) |
| 60220 | 1/4"-3/8" HSS NPT (60115 Die Head) |
| 60360 | 3/4" Beveling Dies for SS (60117 Die Head) |
| 60361 | 1"-2" Beveling Dies for SS (60117 Die Head) |
| 60362 | 3/4" Grooving Dies for SS (60117 Die Head) |
| 60363 | 1"-2" Grooving Dies for SS (60117 Die Head) |
| DIE HEADS | |
| 60115 | 1/4"-2" NPT/Manual Opening |
| 60118●●● | 1/2"-2" NPT/Automatic Opening |
| 60106●●● | 2 1/2"-4" Taper or Straight Threads/Automatic Opening/Notch Type |
| 60117 | 3/4"-2" Beveling & Grooving |
| 60123 | 2 1/2"-4" Beveling & Grooving |
| 60112●●● | 1/2"-3/4" NPT/Automatic Opening/Notch type |
| 60113●●● | 1"-2" NPT/Automatic Opening/Notch type |
| 60114 | 5/16"-2" UNC Bolt/Manual Opening |
| 60116 | 1/2"-2" Conduit/Manual Opening |
| SPARE PARTS AND CART | |
| 60324●●● | Cutter Wheel |
| 60310 | Cutter Wheel |
| 60301 | HSS Cut-Off Blade |
| 60390●● | Cut-Off Blade for 6794 |
| 220204 | HSS 10° Bevel Blade |
| 60307 | Chuck Jaw Insert Set |
| 60327 | Chuck Jaw Insert Set for Plastic Coated Pipe |
| 60506 | Threader Cart NO Toolbox |
| 60507 | Threader Cart with Toolbox |
| 600282 | Straight Profile Block Assembly for 2 1/2"-4" |
| 603680●●● | Wheel Cutoff Assembly |
| 600845●● | Blade Cutoff Assembly |

- Included with basic machine.
- Included with 6794 machine.
- Included with 6793 machine.

6590 2 1/2"-6" MAXIMUM PIPE RANGE

| PART NO. | DIES |
|-------------|---|
| 60206• | 2 1/2"-4" Tapered or Straight (60127 Die Head) |
| 60235 | 2 1/2"-4" NPT S.S. (60127 Die Head) |
| 60253 | 2 1/2"-4" NPT for PVC (60127 Die Head) |
| 60207• | 5"-6" Tapered or Straight (60128 Die Head) |
| 60236 | 5"-6" NPT S.S. (60128 Die Head) |
| 60255 | 5"-6" NPT for PVC (60128 Die Head) |
| 60330 | 2 1/2"-4" Beveling 37.5° (60121 Die Head) |
| 60332 | 2 1/2"-4" S.S. Beveling 37.5° (60121 Die Head) |
| 60331 | 5"-6" Beveling 37.5° (60122 Die Head) |
| 60333 | 5"-6" S.S. Beveling 37.5° (60122 Die Head) |
| 60227 | 2 1/2"-3 1/2" Grooving (60121 Die Head) |
| 60228 | 4" Grooving (60121 Die Head) |
| 60357 | 2 1/2"-3 1/2" Grooving Dies for S.S. (60121 Die Head) |
| 60358 | 4" Grooving Dies for S.S. (60121 Die Head) |
| 60359 | 5"-6" Grooving Dies for S.S. (60122 Die Head) |
| 60229 | 5"-6" Grooving (60122 Die Head) |
| DIE HEADS | |
| 60121 | 2 1/2"-4" Beveling & Grooving |
| 60122 | 5"-6" Beveling & Grooving |
| 60127• | 2 1/2"-4" NPT Notch Style Tapered or Straight Automatic Opening |
| 60128• | 5"-6" NPT Notch Style Tapered or Straight Automatic Opening |
| ACCESSORIES | |
| 60390• | Cut-Off Blade |
| 60301 | HSS Cut-Off Blade |
| 220204 | HSS 10° Bevel Blade |
| 60310 | Cutter Wheel |
| 600280 | Straight Profile Block Assembly |
| 60514 | Threader Cart NO Toolbox |
| 60515 | Threader Cart with Toolbox |
| 60307 | Chuck Jaw Insert Set |
| 60327 | Chuck Jaw Insert Set for Plastic Coated Pipe |

- Included with basic machine.

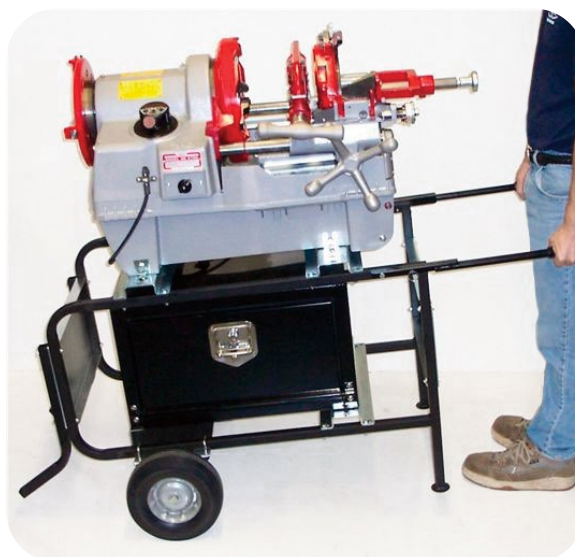

6790 mounted on
60507 cart.

HYDROSTATIC TEST PUMPS

MANUAL HYDROSTATIC TEST PUMPS

Ideal for testing residential water lines. Also for pressure testing small pressure tanks, sprinkler, boiler and solar systems. Lightweight and easy to use. $\frac{3}{4}$ " garden hose female inlet and $\frac{9}{16}$ "-18 JICF male outlet. Equipped with shut off valve, gauge, and adjustable internal relief valve. 10 foot output hose included.



Features: 300psi (20 bar)

- **29200**12 lbs. (5.5kg)

Accessories:

- 3917 10' High-Pressure Output Hose ($\frac{1}{4}$ " NPT male outlet connection)
- 29250 Pump Rebuild Kit
- 34550 10' Long Suction Hose with strainer ($\frac{3}{4}$ " male garden hose connection)

Features: 1000psi (68 bar)

- **29201**12 lbs. (5.5kg)

Accessories:

- 3917 10' High-Pressure Output Hose ($\frac{1}{4}$ " NPT male output connection)
- 29250 Pump Rebuild Kit
- 34550 10' Long Suction Hose with strainer ($\frac{3}{4}$ " male garden hose connection)



Features: 870 psi/60 bar, 1/2" connections

- **29900** with $\frac{1}{2}$ " connections18 lbs. (8kg)

Accessories:

- 3917 10' High-Pressure Output Hose ($\frac{1}{4}$ " NPT male outlet connection)
- 29950 Pump Repair Kit

Designed especially for use in heating, compressed air, refrigeration systems, oil installations and sprinkler systems. Complete with 2.6 gallon stainless steel integral tank and 10 ft. output hose.



GAS POWERED HYDROSTATIC TEST PUMPS

Ideal for certifying the integrity of newly installed or repaired water lines, sewer lines, commercial sprinkler systems, and pressure vessels. All gasoline driven models come with Briggs & Stratton™ Intek Pro or Honda engines and are backed by their warranties. Recirculating systems provide pump protection and water conservation. Carts are wheeled for ease of movement. All units come standard with 10 ft. high-pressure output hose and 10 ft. suction hose with strainer.



ROLLER PUMPS

Features: 5.4 gpm/300 psi (20.5 lpm/21 bar)

- **46301** with 6.5 hp. B&S engine, Cart w/wheels151 lbs. (69kg)
- **463010** with 5.5 hp Honda engine, Cart w/wheels150 lbs. (68kg)

Accessories:

- 36352 Pump Repair Kit
- 34550 10' Suction Hose
- 221065 10' High-Pressure Output Hose



TWIN PISTON PUMPS

Features: 10 gpm/400 psi (38 lpm/28 bar)

- **46453** with 6.5 hp. B&S engine, Cart w/wheels 162 lbs. (74kg)
- **464530** with 5.5 hp Honda engine, Cart w/wheels 159 lbs. (72kg)
- **36454** with 6.5 hp. B&S engine, Roll-cage 136 lbs. (61kg)
- **364540** with 5.5 hp Honda engine, Roll-cage 136 lbs. (61kg)

Accessories:

- 36351 Pump Repair Kit
- 34550 10' Suction Hose
- 221065 10' High-Pressure Output Hose



TRIPLEX PLUNGER PUMP

Features: 3.5 gpm/3000 psi (13 lpm/206 bar)

- **373080** with 8.5 hp. Honda engine, Cage w/wheels 130 lbs. (59kg)

Accessories:

- 36395 Valve Kit
- 36396 Pump Seal Kit
- 34550 10' Suction Hose
- 220577 10' High-Pressure Output Hose



TRIPLEX PLUNGER PUMPS

Features: 3.5 gpm/1200 psi (13 lpm/82bar)

- **46200** with 6.5 hp. B&S engine, Cart w/wheels 130 lbs. (59kg)
- **462000** with 5.5 hp Honda engine, Cart w/wheels 130 lbs. (59kg)
- **36200** with 6.5 hp. B&S engine, Roll-cage 87 lbs. (40kg)
- **362000** with 5.5 hp Honda engine, Roll-cage 87 lbs. (40kg)

Accessories:

- 34052 Pump Repair Kit
- 34053 Pump Seal Kit
- 34550 10' Suction Hose
- 220577 10' High-Pressure Output Hose

HYDROSTATIC TEST PUMPS

CONTINUED



TRIPLE DIAPHRAGM PUMPS

...CAPABLE OF HANDLING 10%
CHLORINE SOLUTIONS

Features: 10 gpm/500 psi (37.8 lpm/35 bar)

Udor Pump Models

- **46501** with 6.5 hp. B&S engine, Cart w/wheels..... 161 lbs. (73kg)
- **465010** with 5.5 hp Honda engine, Cart w/wheels..... 162 lbs. (73kg)
- **46503** with 6.5hp B&S engine, Roll-cage 155 lbs. (70kg)
- **465030** with 5.5hp Honda engine, Roll-cage 155 lbs. (70kg)
- **46506** with 6.5 hp B&S engine, caged with handles and 4 wheels..... 181 lbs. (82kg)
- **465060** with 5.5 hp Honda engine, caged with handles and 4 wheels..... 181 lbs. (82kg)



Comet Pump Models

- **46521** with 6.5 B&S engine, Cart w/wheels..... 155 lbs. (70kg)
- **465210** with 5.5 Honda engine, Cart w/wheels..... 155 lbs. (70kg)
- **46523** with 6.5 B&S engine, Roll-cage 150 lbs. (68kg)
- **465230** with 5.5 Honda engine, Roll-cage 150 lbs. (68kg)
- **46526** with 6.5 hp B&S engine, caged with handles and 4 wheels..... 181 lbs. (82kg)
- **465260** with 5.5 hp Honda engine, caged with handles and 4 wheels..... 181 lbs. (82kg)



Accessories:

- 36345 Pump Repair Kit for 46501, 465010, 46701, 467010
- 36349 Pump Repair Kit for models 46500 and 465000
- 36391 Pump Repair Kit for 46521, 4645210, 46523, 465230, 46526, 465260
- 36345 Pump Repair Kit for 46503, 465030, 46506, 465060
- 34550 10' Suction Hose
- 221065 10' High-Pressure Output Hose for Udor pumps
- 220577 High Pressure Output Hose for Comet pumps
- 34562 Two Wheel & Handle Kit
- 34563 25 Gallon Tank Kit
- 34564 Four Wheel & Handle Kit



TRIPLE DIAPHRAGM PUMPS

...CAPABLE OF HANDLING 10%
CHLORINE SOLUTIONS

Features: 15 gpm/300 psi (57 lpm/21 bar)

- **46600** with 6.5 hp. B&S engine, Cart w/wheels..... 173 lbs. (79kg)
- **466000** with 5.5 hp Honda engine, Cart w/wheels 167 lbs. (76kg)

Features: 32 gpm/300 psi (121 lpm / 21 bar)

- **468260** with 5.5 hp Honda engine, cage w/ 4 wheels..... 226 lbs. (103kg)

Accessories:

- 36347 Pump Repair Kit for models 46600 and 466000
- 36390 Pump Repair Kit for models 46800 and 468000
- 36392 Pump Repair Kit for model 468260
- 34551 10' Intake Hose for models 46600 and 466000
- 700685 10' Intake Hose for model 468260



ELECTRIC POWERED HYDROSTATIC TEST PUMPS PORTABLE

Features: 4 gpm / 300 psi (15 lpm / 20 bar), 1/2hp, 115/230V, 60Hz motor

- **39300** Ideal for certifying fire sprinkler lines, commercial plumbing and industrial testing. Compact, lightweight for portability, but yet powerful and rugged for the professional. Built in adjustable pressure regulator.

Weight34lbs (15kg)

Accessories:

- 39350 Pump Repair Kit
- 34550 10' Suction Hose



TWIN PISTON PUMPS

Features: 3 gpm / 500 psi (11 lpm / 35 bar) 1hp capacitor start motor

- **35100** 115/230V, single phase, 60Hz, Roll-cage 86 lbs. (39kg)
- **35101** 220V, single phase, 50Hz, Roll-cage..... 86 lbs. (39kg)

Accessories:

- 36361 Pump Repair Kit
- 34550 10' Suction Hose



DUPLEX PLUNGER PUMPS

Features: 1 gpm / 1000 psi (3.7 lpm / 68 bar) 1hp capacitor start motor

- **33100** 115/230V, single phase, 60Hz, Roll-cage 110 lbs. (50kg)
- **33101** 220V, single phase, 50Hz, Roll-cage..... 110 lbs. (50kg)

Comet Pump Models

- **33110** 115/230V, single phase, 60 Hz, Roll-cage 110 lbs. (50kg)

Accessories:

- 36389 Pump Repair Kit
- 34550 10' Suction Hose



TRIPLEX PLUNGER PUMPS

Features: Single phase, 1.5hp, 15amp capacitor start motor, Cart w/wheels

- **47100** 2.2gpm / 1000psi (8.3 lpm / 68 bar), 115V, 60Hz 127 lbs. (57kg)
- **47101** 2.2gpm / 1000psi (8.3 lpm / 68 bar), 220V, 59Hz 143 lbs. (65kg)
- **47102** 1.1gpm / 2000psi (4.1 lpm / 138 bar), 115V, 60Hz 127 lbs. (57kg)
- **47103** 1.1gpm / 2000psi (4.1 lpm / 138 bar), 220V, 50Hz 127 lbs. (57kg)
- **47105** 2.2gpm / 2000psi (8.3 lpm / 138 bar), 115V, 60Hz 127 lbs. (57kg)

Accessories:

- 34052 Valve Kit
- 34053 Pump Seal Kit
- 34550 10' Suction Hose



TRIPLEX PLUNGER PUMP

Features: 3.5 gpm / 3000psi (13.25 lpm / 206 bar), 7.5hp 208/230V 3-phase, 60Hz motor

- **37210** On 2-wheeled cart with full perimeter cage. 263 lbs. (120kg)

Accessories:

- 34056 Pump Seal Kit
- 34057 Valve Kit
- 34550 10' Suction Hose

HYDROSTATIC TEST PUMPS

CONTINUED



PNEUMATIC POWERED HYDROSTATIC TEST PUMPS

32150 Lightweight on a Steel Base. 31 lbs. (14kg)

Features: 1 gpm / 1500psi (3.7 lpm / 103 bar) 40-100psi @ 75 cfm required

32300 Lightweight on a Steel Base. 29 lbs. (13kg)

Features: 0.5 gpm/ 3,000psi (1.8 lpm / 206 bar) 40-100 psi @ 75 cfm required

32450 With full perimeter cage. 54 lbs. (24kg)

Features: 0.088gpm / 10,000psi (0.3 lpm / 689 bar) 100 psi @ 28 cfm required

Accessories:

- 32151 Fluid Section Repair Kit for 32150
- 32152 Air Section Repair Kit for 32150 and 32300
- 32301 Fluid Section Repair Kit for 32300
- 32451 Air Section Repair Kit for 32450
- 32452 Fluid Section Repair Kit for 32450



FIRE HOSE TESTERS

363020 Two Hose Tester - Electric. 162 lbs. (74kg)

Features: 3 gpm/500 psi, (11 lpm/35 bar), 115V, single-phase, 1 hp. capacitor motor, one (1) 2 1/2" NST swivel female quick fill inlet and two (2) 2 1/2" NST male outlets with individual ball valves. Cage mounted on swivel casters. Inlet and outlet hoses not provided.

363040 Four Hose Tester - Electric. 179 lbs. (81kg)

Features: 3 gpm/500 psi, (11 lpm/35 bar), 115V, single-phase, 1 hp. capacitor motor, one (1) 2 1/2" NST swivel female quick fill inlet and four (4) 2 1/2" NST male outlets with individual ball valves. Cage mounted on swivel casters. Inlet and outlet hoses not provided

363060 Four Hose Tester - Gas. 222 lbs. (101kg)

Features: 10 gpm/400 psi, (37.8 lpm/27 bar), 5.5hp Honda engine, one (1) 2 1/2" NST swivel female quick fill inlet and four (4) 2 1/2" NST male outlets with individual ball valves. Cage mounted on two-wheeled cart with solid tires.



TRASH PUMPS

Specifically designed pumps for heavy duty applications. Handles solids with ease and simple to open and clean. Standard roll cage protects pump and engine. Steel strainer for intake hose included. Available with either Briggs & Stratton Intek™ Pro or Honda Engines.



2" TRASH PUMPS

Features: 2" Suction / Discharge ports, 180gpm / 681 lpm, max solids up to 1"

- **56200** With 6.5hp B&S Engine (Caged)..... 100 lbs. (45.5kg)
- **56201** With 6.5hp B&S Engine on wheeled cart..... 140 lbs. (63.6kg)
- **562000** With 5.5hp Honda Engine (Caged)..... 100 lbs. (45.5kg)
- **562001** With 5.5hp Honda Engine on wheeled cart..... 140 lbs. (63.6kg)

Accessories:

- 56250 2" x 20' Suction Hose
- 56251 2" x 25' Discharge Hose
- 276270 Pump Repair Kit



3" TRASH PUMPS

Features: 3" Suction/ Discharge ports, 300gpm / 1135 lpm, max solids up to 1.25"

- **56300** With 6.5hp B&S Engine (Caged)..... 132 lbs. (60kg)
- **56301** With 6.5hp B&S Engine on wheeled cart 150 lbs. (68kg)
- **563000** With 5.5hp Honda Engine (Caged)..... 134 lbs. (61kg)
- **563001** With 5.5hp Honda Engine on wheeled cart..... 150 lbs. (68kg)

Accessories:

- 56350 3" x 15' Suction Hose
- 56351 3" x 25' Discharge Hose
- 276271 Pump Repair Kit



MUDSUCKER DIAPHRAGM STYLE TRASH PUMPS

Features: 3" Suction/Discharge ports, 90gpm / 340 lpm; for sewage, slurry, mud, thick liquids, max solids up to 1-5/8"

- **56310** With 6.5hp B&S Engine..... 179 lbs. (81kg)
- **563100** With 5.5hp Honda Engine..... 181 lbs. (82kg)

Accessories:

- 56350 3" x 15' Suction Hose
- 56351 3" x 25' Discharge Hose



VACUUM TEST ASSEMBLY

700536 1 lb. (0.45kg)

An easy way to check a trash pump for proper suction. Verify proper operation before putting a pump into service. Simply prime pump, place flat face over suction port and start pump.

PIPE WORKING TOOLS



4160 TRIPOD VISE STAND

For 1/8"-6" pipe capacity. Lightweight and portable with a large top working area. It features a built-in chain vise, pipe bending slots, pipe rest, ceiling brace screw and hardened replaceable jaws. The lower tray folds for extra convenience.

Weight50 lbs. (22kg)

606738 Replacement Chain

606739 Replacement Jaws



4180 BENCH VISE

This new heavy duty bench vise is ideal for a wide range of pipe working from 1/8" OD to 6" OD and features a reinforced steel chain and replaceable hardened jaws. Mounting bolts are included. It is ideal for a multitude of applications.

Weight19 lbs. (8.6kg)

600015 Replacement Chain

600016 Replacement Jaws



850 Shown Collapsed

FOLDING TRIPOD PIPE SUPPORTS

Tripod Pipe Supports are designed to hold stock for threading machines, chop saws, and other equipment. Sturdy, all steel construction supports hold up to one ton (2000 lbs.) of materials: pipe, tubing, conduit, bar, rod, or structural steel. Quick-release locking ring allows for fast height adjustments, while 1 1/2" diameter Acme threads on the adjusting column provide fine height adjustments. Heavy duty lockscrew maintains height safely.

Height range is 27" - 50" (675-1250mm). Capacity: 1/2" - 16" (12-400mm) Diameter.

850 With standard V-head, Weight.....28 lbs. (13kg)

851 With heavy duty ball transfer head, Weight32 lbs. (14.5kg)

854 Ball Transfer Head only for use on standard V-head





YOKE VISES

These vises firmly hold pipe and round bar stock for cutting, drilling, and threading operations. Vises are reversible for left or right opening. All jaws are made of hardened steel and can easily be replaced in the field. The yoke and base are constructed of high-grade malleable iron. Meets all Federal Specifications: GGG-V-415a Type 1, Class II.

| Product | O.D. Capacity | Weight |
|---------|--|------------------|
| 13020 | $\frac{3}{8}$ " - $2\frac{3}{8}$ " (60mm) | 10 lbs. (4.5kg) |
| 13040 | $\frac{3}{8}$ " - $3\frac{1}{2}$ " (89mm) | 18 lbs. (8kg) |
| 13060 | $\frac{3}{8}$ " - $4\frac{1}{2}$ " (114mm) | 28 lbs. (12.7kg) |
| 13080 | $\frac{3}{8}$ " - 5" (127mm) | 27 lbs. (12kg) |



FLOOR MODEL PIPE VISES

WHEELER-REX Pipe Vises are designed to be portable and quickly assembled for field use, yet strong and tough enough for the shop. All models have a 2000 lb. (900kg) capacity. The quick releasing chain provides positive gripping power evenly around the pipe and prevents damage to pipe surfaces. Adjustments are fast to accommodate different pipe sizes.

| | | |
|--------|---|-----------------------------|
| 401500 | Capacity: $\frac{3}{4}$ " to 15" (18-375mm) | Weight.....54 lbs. (24.6kg) |
| 402000 | Capacity: $\frac{3}{4}$ " to 20" (18-500mm) | Weight.....55 lbs. (25kg) |
| 402800 | Capacity: $\frac{3}{4}$ " to 28" (18-700mm) | Weight.....56 lbs. (25.5kg) |



PIPE PULLER

For joining all types of gasketed pipe: plastic, cast iron, clay, and concrete. Comes with two 12 ft. long anchor chains. Also pulls fittings, valves, and couplings into place. Lightweight yet rugged, this tool operates on a basic lever action and is used easily by one person.

| | | |
|------|--|---------------------------|
| 4012 | Pipe Capacity: 4" - 14" (100-350mm) Diameter | Weight.....33 lbs. (15kg) |
|------|--|---------------------------|



PIPE DOLLY

These dollies are used to support, rotate and align pipes. They are extremely heavy duty with 1" (25mm) diameter axle shafts. All steel construction. Normally used in pairs.

| | | |
|-----|---|-----------------------------|
| 880 | Capacity: 3" - 30" (75-750mm) pipe, 2500 lb. load rating each | Weight.....23 lbs. (10.5kg) |
|-----|---|-----------------------------|

Heavy Duty Iron Pipe Wrenches have I-Beam handles for proven strength and durability without excess weight. Full floating jaws have spring suspension for fast grip and release. Replaceable jaws are made of tough heat-treated alloy steel. Aluminum Wrenches are nearly 50% less weight compared to Iron Wrenches. The End Wrenches and the Off-Set Wrenches allow for usage in areas with space restrictions. All Pipe Wrenches are made to U.S. Federal Specifications. Parts are interchangeable with most major brands and carry a limited lifetime warranty.

HEAVY DUTY STRAIGHT IRON PIPE WRENCHES

Manufactured to U.S. Specifications GGG-W-651e Type II Class A



| Model Number | Description | Pipe Capacity | | Weight | | Std Pack |
|--------------|-----------------------------------|---------------|-----|--------|------|----------|
| | | Inches | mm | lbs | Kg | |
| 4508 | 8" (200mm) Straight Pipe Wrench | 1 | 25 | 3/4 | 0.3 | 6 |
| 4510 | 10" (250mm) Straight Pipe Wrench | 1 1/2 | 40 | 1 3/4 | 0.8 | 6 |
| 4512 | 12" (300mm) Straight Pipe Wrench | 2 | 50 | 2 3/4 | 1.2 | 6 |
| 4514 | 14" (350mm) Straight Pipe Wrench | 2 | 50 | 3 1/2 | 1.6 | 6 |
| 4518 | 18" (450mm) Straight Pipe Wrench | 2 1/2 | 65 | 5 3/4 | 2.6 | 6 |
| 4524 | 24" (600mm) Straight Pipe Wrench | 3 | 80 | 9 3/4 | 4.4 | 4 |
| 4536 | 36" (900mm) Straight Pipe Wrench | 5 | 125 | 19 | 8.7 | 1 |
| 4548 | 48" (1200mm) Straight Pipe Wrench | 6 | 150 | 34 | 15.5 | 1 |
| 4560 | 60" (1524mm) Straight Pipe Wrench | 8 | 200 | 51 1/4 | 23.3 | 1 |

HEAVY DUTY END IRON PIPE WRENCHES

Manufactured to U.S. Specifications GGG-W-651e Type VI



| Model Number | Description | Pipe Capacity | | Weight | | Std Pack |
|--------------|-----------------------------|---------------|----|--------|-----|----------|
| | | Inches | mm | lbs | Kg | |
| 4710 | 10" (250mm) End Pipe Wrench | 1 1/2 | 40 | 1 3/4 | 0.8 | 6 |
| 4714 | 14" (350mm) End Pipe Wrench | 2 | 50 | 3 1/2 | 1.6 | 6 |
| 4718 | 18" (450mm) End Pipe Wrench | 2 1/2 | 65 | 5 3/4 | 2.6 | 3 |

ALUMINUM STRAIGHT PIPE WRENCHES

Manufactured to U.S. Specifications GGG-W-651e Type II Class C



| Model Number | Description | Pipe Capacity | | Weight | | Std Pack |
|--------------|--------------------------------|---------------|-----|--------|-----|----------|
| | | Inches | mm | lbs | Kg | |
| 4410 | 10" (250mm) Aluminum Straight | 1 1/2 | 40 | 1 | 0.4 | 6 |
| 4414 | 14" (350mm) Aluminum Straight | 2 | 50 | 2 1/2 | 1.1 | 6 |
| 4418 | 18" (450mm) Aluminum Straight | 2 1/2 | 65 | 3 3/4 | 1.7 | 6 |
| 4424 | 24" (600mm) Aluminum Straight | 3 | 80 | 6 | 2.7 | 6 |
| 4436 | 36" (900mm) Aluminum Straight | 5 | 125 | 11 | 5 | 4 |
| 4448 | 48" (1200mm) Aluminum Straight | 6 | 150 | 19 | 8.7 | 1 |

ALUMINUM OFF-SET PIPE WRENCHES

Manufactured to U.S. Specifications GGG-W-651 Type II Class C



| Model Number | Description | Pipe Capacity | | Weight | | Std Pack |
|--------------|------------------------------|---------------|----|--------|-----|----------|
| | | Inches | mm | lbs | Kg | |
| 4814 | 14" (350mm) Aluminum Off-Set | 2 | 50 | 2 | 0.9 | 6 |
| 4818 | 18" (450mm) Aluminum Off-Set | 2 1/2 | 65 | 3 1/2 | 1.6 | 6 |
| 4824 | 24" (600mm) Aluminum Off-Set | 3 | 80 | 5 | 2.3 | 6 |



GRIPMASTER

The GripMaster is a one-handed operation wrench which provides a fast, secure grip. Spring-loaded jaws for fast placement on pipe and secure ratchet action.

| Model Number | Description | Pipe Capacity | | Weight | | Std Pack |
|--------------|----------------|---------------|------|--------|-----|----------|
| | | inches | mm | lbs | kg | |
| 4310 | 10" GripMaster | 1 1/2 | 37.5 | 2 | 0.9 | 6 |
| 4314 | 14" GripMaster | 2 | 50 | 4 | 1.8 | 6 |



SPUD WRENCH

The 4612 Spud Wrench is for 3/8"-2 5/8" pipes and is designed with narrow jaws to fit into small spaces. The smooth jaws are the perfect tool when toothed jaws may not be the right choice for the job.

| Model Number | Description | Pipe Capacity | | Weight | | Std Pack |
|--------------|-----------------|---------------|----|--------|-----|----------|
| | | inches | mm | lbs | kg | |
| 4612 | 12" Spud Wrench | 2 5/8 | 67 | 2.7 | 1.2 | 6 |



5400 LIGHT DUTY CHAIN WRENCH

With forged alloy steel handles, the 5400 is ideal for use in small locations. The 5400 is designed for pipes up to 4" O.D. Chain length is 15 3/4"; handle length is 12".

Weight.....2.5 lbs. (1.2kg)



STRAP WRENCHES

Provides quick gripping to plastic or chrome plated objects without scratching or damaging the surface. Neoprene Coated Strap. Ductile iron handles for high strength.

| Model No. | Pipe capacity | O.D. Capacity | Handle Length |
|-----------|----------------------------|-----------------------|-----------------------------|
| 8312 | 1/8"-2" (10-63mm) | 1/8"-3 1/2" (10-90mm) | 12" (305mm) weight 2.0 lbs. |
| 8318 | 1"-5" (33-127mm) | 1"-6" (33-150mm) | 18" (458mm) weight 3.3 lbs. |
| 8324 | 2"-12" (60-324mm) | 2"-14" (60-350mm) | 24" (610mm) weight 5.7 lbs. |
| 83120 | Replacement Strap for 8312 | 83121 | Replacement Wedge for 8312 |
| 83180 | Replacement Strap for 8318 | 83181 | Replacement Wedge for 8318 |
| 83240 | Replacement Strap for 8324 | 83241 | Replacement Wedge for 8324 |



BASIN WRENCH

Quickly & easily tightens or loosens faucet shank nuts in close quarters. Complete with spring loaded jaws and a friction plug that helps hold the head in position. 3/8" to 1 1/4" capacity.

9401 Basin Wrench 2 lbs. (0.9kg)



Replaceable Socket

SOIL PIPE COUPLING TORQUE WRENCH

This durable "T-Handle" type torque tool with a contoured comfort-fit handle features a removable socket and a unique locking collar, which allows the tool to be used as an untorqued snug-up or back-off, as well as a conventional torque tool. With the locking collar retracted, the tool torques to the right (tightening), while ratcheting to the left. When proper torque value has been achieved, the mechanism slips internally and over-tightening is impossible.

- 1977 T-Torque for tightening $\frac{5}{16}$ " coupling nuts to 60 in. lbs. Weight 1 lb. (0.5kg)
 - 1980 T-Torque for tightening $\frac{5}{16}$ " coupling nuts to 80 in. lbs. Weight 1 lb. (0.5kg)
 - 1981 T-Torque for tightening $\frac{3}{8}$ " coupling nuts to 80 in. lbs. Weight 1 lb. (0.5kg)
 - 1982 T-Torque for tightening $\frac{5}{16}$ " & $\frac{3}{8}$ " coupling nuts to 80 in. lbs. Weight 1 lb. (0.5kg)
- 275410 $\frac{5}{16}$ " Replacement Socket
- 275818 $\frac{3}{8}$ " Replacement Socket



NO-HUB® COUPLING WRENCHES

WHEELER-REX powered No-Hub® Coupling Wrenches tighten or loosen couplings in just a few seconds. The tools can be used with most $\frac{3}{8}$ " reversible electric drills. They can be installed and removed as quickly as a drill bit. Automatic clutch in torque heads prevent over and under tightening. Recalibration is easy with a torque wrench.



- 1964 "Fastite" for tightening $\frac{5}{16}$ " coupling nuts to 60 in. lbs. Weight 0.8 lb. (0.36kg)
- 1965 "Fastite Plus" for tightening $\frac{3}{8}$ " coupling nuts to 80 in. lbs. Weight 0.8 lb. (0.36kg)
- 1966 "Fastite Plus 2" for tightening $\frac{5}{16}$ " coupling nuts to 80 in. lbs. Weight 0.8 lb. (0.36kg)



HYDRANT WRENCH

For removing hydrant caps and operating hydrants. Made of sturdy forged construction; will fit pentagon nuts up to $1\frac{3}{4}$ " or square nuts up to $1\frac{1}{4}$ " with spanners for either pin or lug style host couplings.

- 8700 Hydrant Wrench5 lbs. (2.5kg)



DOUBLE-UP WRENCH

One through-bolt wrench with two sockets makes for fast, easy tightening of your repair clamp and service saddle nuts. Easy reversing with a single lever. Strong, all steel construction with a vinyl grip.

- 9600 $1\frac{1}{4}$ " x $1\frac{1}{16}$ " Double-Up Wrench 2.75 lbs.
- 9601 $1\frac{5}{16}$ " x $1\frac{1}{8}$ " Double-Up Wrench 2.75 lbs.

HEAVY DUTY DEEP SOCKETS

Designed for tightening hex nuts on repair clamps, mechanical joint fittings, and saddles. Large diameter barrels make fast hand tightening easy. Operates with any 1/2" drive manual or impact wrench. Twelve individual kits are available.



Individual Six Point Deep Sockets

| | | | | |
|-----|---------|-------------------|-----------|---------|
| 978 | 3/4" | Deep Socket 6 pt. | 1 lbs. | (0.5kg) |
| 979 | 7/8" | Deep Socket 6 pt. | 1 lbs. | (0.5kg) |
| 980 | 1 1/16" | Deep Socket 6 pt. | 1.2 lbs. | (0.5kg) |
| 981 | 1 1/16" | Deep Socket 6 pt. | 1.4 lbs. | (0.6kg) |
| 982 | 1 1/4" | Deep Socket 6 pt. | 1.5 lbs. | (0.7kg) |
| 983 | 1 1/8" | Deep Socket 6 pt. | 1.5 lbs. | (0.7kg) |
| 984 | 1 5/16" | Deep Socket 6 pt. | 1.85 lbs. | (0.8kg) |
| 985 | 1 7/16" | Deep Socket 6 pt. | 2.15 lbs. | (1kg) |
| 986 | 1" | Deep Socket 6 pt. | 1.2 lbs. | (0.5kg) |
| 987 | 1 1/2" | Deep Socket 6 pt. | 2.3 lbs. | (1kg) |
| 947 | 17mm | Deep Socket 6 pt. | .85 lbs. | (0.4kg) |
| 943 | 19mm | Deep Socket 6 pt. | .95 lbs. | (0.4kg) |
| 944 | 22mm | Deep Socket 6 pt. | 1.05 lbs. | (0.5kg) |
| 945 | 24mm | Deep Socket 6 pt. | 1.15 lbs. | (0.5kg) |
| 948 | 27mm | Deep Socket 6 pt. | 1.4 lbs. | (0.6kg) |
| 946 | 30mm | Deep Socket 6 pt. | 1.55 lbs. | (0.7kg) |

Kits Available with Deep Sockets in Tool Box with 6515 Ratchet as Follows:

| | | | |
|-----|---|-----------|-----------|
| 960 | Includes 980 - 1 5/16", 981 - 1 1/16", 982 - 1 1/4" | 7.75 lbs. | (3.5kg) |
| 961 | Includes 980 - 1 5/16", 981 - 1 1/16", 982 - 1 1/4", 983 - 1 1/8" | 9 lbs. | (4kg) |
| 962 | Includes 980 - 1 5/16", 982 - 1 1/4", 983 - 1 1/8" | 7.75 lbs. | (3.5kg) |
| 963 | Includes 981 - 1 1/16", 982 - 1 1/4", 984 - 1 5/16", 985 - 1 7/16" | 13 lbs. | (5.9kg) |
| 964 | Includes 981 - 1 1/16", 982 - 1 1/4", 983 - 1 1/8" | 8 lbs. | (3.6kg) |
| 965 | Includes 979 - 7/8", 981 - 1 1/16", 982 - 1 1/4" | 7.6 lbs. | (3.45kg) |
| 966 | Includes 978 - 3/4", 979 - 7/8", 980 - 1 5/16", 981 - 1 1/16" | 8 lbs. | (3.6kg) |
| 967 | Includes 978 - 3/4", 979 - 7/8", 980 - 1 5/16", 981 - 1 1/16", 982 - 1 1/4", 983 - 1 1/8", 984 - 1 5/16", 985 - 1 7/16", 986 - 1", 987 - 1 1/2" | 20 lbs. | (9kg) |
| 968 | Includes 978 - 3/4", 979 - 7/8", 980 - 1 5/16", 981 - 1 1/16", 982 1 1/4", 983 1 1/8" 16 | 16 lbs. | (7.26 kg) |

Kits with Deep Sockets in Metric Sizes:

| | | | |
|-----|---|---------|---------|
| 940 | Includes 943- 19mm, 944- 22mm, 945- 24mm | 7 lbs. | (3kg) |
| 941 | Includes 943- 19mm, 944- 22mm, 945- 24mm, 946- 30mm | 8 lbs. | (3.6kg) |
| 942 | Includes 947- 17mm, 943- 19mm, 945- 24mm, 946- 30mm | 20 lbs. | (9kg) |
| 950 | Includes 947- 17mm, 943- 19mm, 944- 22mm, 945- 24mm, 948- 27mm, 946- 30mm | 13 lbs. | (5.9kg) |

DIAMETER TAPE

For measuring diameter or circumference of pipes and cylindrical objects.



| | | | |
|----|--|-----------------|----------|
| 71 | Pocket size 6' (1.82m) linear / 22" (.56m) Diameter Tape. English/Metric Scales. | Weight 0.35 lbs | (0.16kg) |
|----|--|-----------------|----------|

PIPE CLEANER (Descaler)

A versatile scraper for removing mud and scale from pipe surfaces. Makes for faster cutting and better repairs and joints. Belt material is light, strong and non-corroding. Angled blades promote self-cleaning. Belt is replaceable, longer length reduces back strain.



| | | | |
|------|------------------------------|--------|---------|
| 1300 | For 3-12" diameter, 45" OAL | 4 lbs. | (2kg) |
| 1301 | Replacement Belt, 45" | 3 lbs. | (1.5kg) |
| 1350 | For 12-36" diameter, 72" OAL | 5 lbs. | (2.5kg) |
| 1351 | Replacement Belt, 72" | 4 lbs. | (2kg) |



ARCTIC POLAR SYSTEM® PIPE FREEZING KIT

Designed specifically for the professional, WHEELER-REX Pipe Freezing Kits will rapidly form an ice plug in static water lines eliminating the need to drain down a system to make a repair. Ice plugs will last 15 to 20 minutes and can be easily renewed.

Kit comes complete with jackets for double freezes. No tools are required to set up and complete a freeze. An easy-to-use scale is included to ensure economical operation. Packaged in a convenient carrying case.

Polar Spray is non-toxic, non-flammable and ozone friendly. (Tetrafloraethane)

TWO CAN PIPE FREEZING KIT

- 1755 $\frac{3}{8}$ "– $2\frac{3}{8}$ " O.D. Kit includes the following:
 2 jackets each – 17550 for $\frac{3}{8}$ "– $\frac{1}{2}$ ", 17551 for $\frac{5}{8}$ "– $\frac{7}{8}$ ", 17552 for 1"– $1\frac{3}{8}$ ",
 17553 for $1\frac{5}{8}$ ", 17554 for 2"– $2\frac{3}{8}$ ", valve, scale, t-fitting and 5' tubing.
 Weight.....11.5 lbs. (5.3kg)
- 17500 Polar Spray Replacement Canister *per can*2 lbs. (0.9kg)
 (Available in cases of 12 or individually)



REPLACEMENT CANISTERS



WHEELER-REX's Pipe Freeze Kits install in seconds on pipes up to $2\frac{3}{8}$ " O.D. and require no special tools. Ice plugs last 15–20 minutes and can be easily renewed.



SHUTOFF TOOLS

SHUT OFF TOOLS FOR SOFT COPPER PIPE

Our shut off tools are invaluable for maintenance and installation of soft copper service lines where they can shut off, hold, and restore flow quickly and easily. They are handy for quick repairs with their swing-out design. Complete with socket, ratchet, holding clamp, and carrying case.

New & Improved — with Grease Fitting



- | | | |
|-------------|--|---|
| 85 | Capacity: 3/4" (20mm) through 1" (25mm) soft copper tubing Includes: ratchet, carrying case and #62 clamp. Weight..... 12 lbs. (5.5kg) |  |
| 86 | Capacity: 1/2" (12mm) through 1" (25mm) soft copper tubing Includes: ratchet, carrying case and #62 clamp. Weight..... 13 lbs. (5.9kg) | |
| 70 | Capacity: 1 1/4" (31mm) through 2" (50mm) soft copper tubing Includes: ratchet, carrying case and #72 clamp. Weight..... 19 lbs. (8.6kg) |  |
| 8570 | Combination of Models 85 and 70 Includes: ratchet, carrying case and clamps. Weight..... 26 lbs. (11.8kg) |  |
| 8670 | Combination of Models 86 and 70 Includes: ratchet, carrying case and clamps. Weight..... 26 lbs. (11.8kg) | |

Accessories:

- | | |
|---------------|--|
| 62 | 1/2" (12mm) through 1" (25mm) Clamp for soft copper pipe |
| 72 | 1 1/4" (31mm) through 2" (50mm) Clamp for soft copper pipe |
| 6515 | 1/2" Square Male Drive Ratchet |
| 221220 | Conversion Kit from 85 to 86 |
| 506032 | 1" x 1/2" Square Drive Socket |

SHUT OFF TOOLS FOR PLASTIC PIPE

These unique portable valves shut off the flow of either water or gas in Polyethylene or Polybutylene plastic pipe. They are especially handy for fast on-the-spot repairs. Complete with socket, ratchet, and carrying case.



- | | |
|-----------|---|
| 75 | Capacity: 3/8" to 2" (10–50mm) plastic water pipe. Includes: ratchet and carrying case. Weight..... 12 lbs. (5.4kg) |
| 77 | With adjustable stops to prevent damage to pipe. Capacity: 3/8" to 2" (10–50mm) Plastic gas pipe. Includes: ratchet and carrying case. Weight..... 12 lbs. (5.4kg) |

ORDER NOW

Eastern Time 1-800-321-7950

Fax 440-992-2925

wheeler@wheelerrex.com

DRILLING AND TAPPING TOOLS

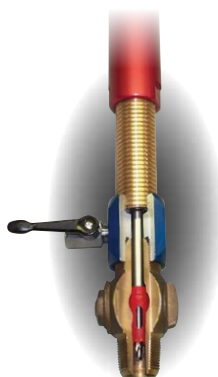

Cutaway View



HOT TAPPING SYSTEM

Capacity: from 3/4" to 2" (19–50mm) in Steel, Cast Iron, Ductile, and Plastic Pipe. The WHEELER-REX Hot Tapping System is hand operated and designed for drilling holes in active water lines up to 250 psi. It is lightweight and easy for one person to set up and use. Complete with 6515 ratchet, tool box, adapters and cutter shells for making 3/4" (19mm) and 2" (50mm) holes.

Built-in bleed-off valve allows chips to be flushed away.

| Model | Pipe Size | Description | Use |
|-------------|-----------|--|---|
| 8100 | 3/4" - 1" | Complete with 3/4" & 1" NPT Adapters and HSS Cutter Shells for Steel and Copper Pipe. | STEEL & COPPER |
| 8102 | 3/4" - 2" | Complete with 3/4", 1", 1 1/2", & 2" NPT Adapters and HSS Cutter Shells for Steel and Copper Pipe, Includes Large Arbor Assembly. | STEEL & COPPER |
| 8200 | 3/4" - 1" | Complete with 3/4" & 1" CTS Flare Adapters and HSS Cutter Shells for Steel and Copper Pipe. | STEEL & COPPER |
| 8201 | 3/4" - 1" | Complete with 3/4" & 1" CTS Flare Adapters and Cutter Shells for Plastic Pipe. | PLASTIC |
| 8202 | 3/4" - 2" | Complete with 3/4", 1", 1 1/2", & 2" CTS Flare Adapters and Cutter Shells for Plastic Pipe, Includes Large Arbor Assembly. | PLASTIC |
| 8203 | 3/4" - 1" | Complete with 3/4" & 1" CTS Flare Adapters and Cutter Shells for Ductile & Cast Iron Pipe. | DUCTILE/CAST IRON |
| 8204 | 3/4" - 2" | Complete with 3/4", 1", 1 1/2", & 2" CTS Flare Adapters and Cutter Shells for Ductile and Cast Iron Pipe, Includes Large Arbor Assembly. | DUCTILE/CAST IRON |
| 8205 | 3/4" - 1" | Complete with 3/4" & 1" CTS Flare Adapters and Cutter Shells for Plastic, Ductile and Cast Iron Pipe. | PLASTIC, DUCTILE & CAST IRON |
| 8206 | 3/4" - 2" | Complete with 3/4", 1", 1 1/2", & 2" CTS Flare Adapters and Cutter Shells for Plastic, Ductile and Cast Iron Pipe, Includes Large Arbor Assembly. | PLASTIC, DUCTILE & CAST IRON |
| 8209 | 3/4" - 2" | Complete with 3/4", 1", 1 1/2", & 2" CTS Flare Adapters, 1 1/2" & 2" Compression Style Adapters, and Cutter Shells for Plastic, Ductile and Cast Iron Pipe, Includes Large Arbor Assembly. | PLASTIC, DUCTILE & CAST IRON |
| 8300 | 3/4" - 1" | Complete with 3/4" & 1" BSPT Adapters and HSS Cutter Shells for Steel and Copper Pipe. | STEEL & COPPER |

| ADAPTERS FOR NPT THREAD | ADAPTERS FOR CTS FLARE | ADAPTERS FOR BSPT THREAD | COMPRESSION STYLE CORP STOP MUELLER 110 | CUTTER SHELLS FOR STEEL AND COPPER | CUTTER SHELLS FOR DUCTILE IRON & CAST IRON | CUTTER SHELLS FOR PLASTIC C-900 | OTHER ACCESSORIES |
|-------------------------|------------------------|--------------------------|---|------------------------------------|--|---------------------------------|---|
| 802051 3/4" | 802050 3/4" | 802071 3/4" | 802060 1-1/2" ADAPTER | 903071 3/4" | 904065 3/4" | 5800 3/4" | 6515 RATCHET |
| 802053 1" | 802052 1" | 802072 1" | 802061 2" ADAPTER | 903072 1" | 904066 1" | 5801 1" | 908097 THREADED BUSHING |
| 802055 1-1/4" | 802054 1-1/4" | 802073 1-1/4" | | 903073 1-1/4" | 904067 1-1/4" | 5803 1-1/4" | 908094 CENTER DRILL |
| 802057 1-1/2" | 802056 1-1/2" | 802074 1-1/2" | | 903074 1-1/2" | 904068 1-1/2" | 802084 1-1/2" | 908098 CENTER DRILL W/ COUPON RETAINER |
| 802059 2" | 802058 2" | 802075 2" | | 903075 2" | 904069 2" | 802085 2" | |

701440 1-1/2" & 2" ARBOR ASSEMBLY - HOT TAP SYSTEM ADAPTER

Reinforced Arbor for cutting larger holes in difficult materials. To be used with 1-1/2" and 2" cutter shells for all three WHEELER-REX hot tap systems. The new arbor design has drive pins that align with holes in the large cutter shells for a stronger assembly.

Weight.....2 lbs. (0.9kg)

COMBINED DRILL TAPS

WHEELER-REX's combined drill taps bring you premium performance at a reasonable price. Designed and manufactured to produce a quality thread and ensure a pressure tight fit. Made from high speed steel, they are tough and durable and fit all popular tapping machines.



WHEELER-REX Drill Taps will fit all popular tapping machines including:

Mueller B100 • Mueller B101 • Mueller A2 • Mueller A3 • Hays Transmate B1 • All Reed

| | | | |
|-------|----------------------------------|-----------|----------|
| 89075 | 3/4" CC Thread Drill Tap | 1.1 lbs. | (0.49kg) |
| 89150 | 1-1/2" CC Thread Drill Tap | 2.75 lbs. | (1.24kg) |
| 89100 | 1" CC Thread Drill Tap | 1.3 lbs. | (0.6kg) |
| 89200 | 2" CC Thread Drill Tap | 3.85 lbs. | (1.74kg) |
| 86075 | 3/4" CC PVC Drill Tap | 1 lb. | (0.45kg) |
| 86100 | 1" CC PVC Drill Tap | 1.5 lbs. | (0.68kg) |

Resharping service only available for WHEELER-REX CC Thread Drill Taps (not available for PVC Drill Taps).



TAPPING FLUID

A completely new concept in a lubricant for drill taps and other related uses where a non-toxic food grade lubricant is required. Slik-tap is easy to apply, yet thick enough to hang onto the cutting tool, providing the lubrication to reduce tapping effort and produce clean threads.

| | | | |
|------|--|----------|----------|
| 8900 | 1 pint of Tapping Fluid Slik-Tap | 1.5 lbs. | (0.68kg) |
| 8901 | 12 pack of 8900 Tapping Fluid Slik-Tap | 14 lbs. | (6.35kg) |

PORTABLE HOLE CUTTER SYSTEM

A compact, light-weight hole cutter system that utilizes a drill to cut a hole in pipes. Designed to cut most materials, including steel.



3092

Without drill – provide your own:

| | | | |
|------|---|---------|--------|
| 3090 | With adapter only for Milwaukee® Drill (less drill) | 46 lbs. | (21kg) |
| 3091 | With adapter only for DeWalt® DW130V Drill (less drill) | 46 lbs. | (21kg) |

With drill:

| | | | |
|--------|--|---------|---------|
| 3092 | Hole Cutter System with Milwaukee® Model 1660-6 Drill | 57 lbs. | (26kg) |
| 3093 | Hole Cutter System with DeWalt® DW130V Drill | 57 lbs. | (26kg) |
| 701173 | Drill Adapter Kit for DeWalt® 131 Drill for all models | 1 lb. | (0.5kg) |

Accessories:

| | |
|--------|--------------|
| 908094 | Center Drill |
|--------|--------------|



3093

Features:

- Cuts holes up to 4 3/4" (120mm)
- For use with standard off-the-shelf hole saw **(not included)**
- Comes standard with metal carrying case
- Comes standard with enough chain for 10" pipes, extra chain available
- Handle can be changed for right or left feed
- Rack & pinion feed gear
- Fast, easy, secure mounting to pipe
- Spring loaded pin holds drill in position
- Comes complete and ready to use with either:
DeWalt® DW130V Drill or Milwaukee® 1660-6 Drill

DRILLING AND TAPPING TOOLS

CONTINUED



1661
PNEUMATIC



1660
GAS



1663
HYDRAULIC



701186
Bypass Valve



HOLE CUTTER SYSTEM

The WHEELER-REX Hole Cutter System is designed to easily cut holes from 4"-12" (100-300mm) into clay tile, ductile and cast iron, plastic and reinforced concrete pipes. The unit is available with a variety of power sources including 2-cycle gasoline engine, pneumatic motor, electric motor and hydraulic motor. The system is modular in design which allows a single operator to set up and perform non-pressure taps safely and quickly. The basic system can be used on pipes from 6"-20" (150-500mm) O.D. and the capacity can be extended by simply adding chain to the hold down mechanism. Set up normally takes 5-10 minutes and actual cutting time is 5-10 minutes depending on pipe material and wall thickness.

- 1660 Complete with gasoline power pack and water valve assembly
Shipping weight (less cutter shells)..... 108 lbs. (49kg)
- 1661 Complete with air power pack and water valve assembly, 70-80 psi (4.6-5.5 bar),
50-60 cfm (1400-1700 lpm) Shipping weight (less cutter shells)..... 123 lbs. (55.9kg)
- 276582 Air Motor Repair Kit
- 1662 Complete with 115V electric motor and water valve assembly
Shipping weight (less cutter shells)..... 102 lbs. (46kg)
- 1663 Complete with hydraulic motor and water valve assembly, 8 gpm, 2000 psi
(30 lpm @ 130 bar) Shipping weight (less cutter shells)..... 100 lbs. (45.45kg)
Requires external hydraulic source. See page 9 for Model 6500 Hydraulic Power Pack
- 1664 Hole Cutter System less drive 93 lbs. (43kg)
- 701186 Bypass Valve for 1663 Hole Cutter System 8 gpm, 2000 psi..... 10.5 lbs. (4.7kg)

The Model 701186 is a Bypass Valve Kit designed to be used with your skid loader, backhoe or tractor for the WHEELER-REX Model 1663 Hydraulic Hole Cutter System. The 701186 will adapt your current hydraulic system to the specs required to operate the 1663 Hole Cutter System. (8 gpm and 2000 psi required) Portable at 10 pounds and easy to connect. The hole cutter's hydraulic lines will directly attach to the quick disconnects for both input & output points on the bypass valve. Hydraulic lines not included (between hydraulic power source & bypass valve.)

- 210 HSS Center Drill for CI, DI & Plastic Pipe
- 211 Carbide-Tipped Center Drill for Clay and Concrete
- 220025 Coupon Retainer

HOLE CUTTER SHELLS

| Nominal Hole Size | Clay Concrete | Reinforced Concrete, Clay, Ductile & Cast Iron | Plastic |
|-------------------|---------------|--|---------|
| 4" (100mm) | 3395* | 6395* | 4395 |
| 4 1/2" (112mm) | 3450* | 6450* | 4450 |
| 6" (150mm) | 3595* | 6595* | 4595 |
| 6 1/2" (172mm) | 3650* | 6650* | 4650 |
| 8" (200mm) | | 6800* | 4800 |

* Water coolant required

Larger sizes available upon request

EARTHWORM HYDRO-DRILL

Bores holes underground without trenching or disturbing surface materials. Ideal for installing water, gas, drain, and electrical lines. Comes standard with a combination drive/water valve assembly, and a 2" (50mm) diameter auger. User supplies 3/4" pipe for drill shaft.

- 7800 Weight 3.65 lbs. (1.65kg)

Additional Augers

- 7801 1" (25mm) Auger
- 7802 2" (50mm) Auger
- 7810 3" (75mm) Auger
- 7808 4" (100mm) Reversing Auger
- 7809 6" (150mm) Reversing Auger



PIPE SLICES

8600 PIPE SLICE with 1" NPT Male Threads, 3 Blades.....3 lbs. (1.4kg)

Recommended for replacing existing copper, galvanized, and lead service lines.

Kits:

8631 Includes 8600 Pipe Slice, 8610 Cable Grip, 8625 & 8626 Poly/Copper Pipe Pulling Attachments18 lbs. (8kg)
8632 Includes 8600 Pipe Slice, 8611 Cable Grip, 8625 & 8626 Poly/Copper Pipe Pulling Attachments18 lbs. (8kg)

Accessories:

8605 3/8" x 50' Cable with Ferrule.....16 lbs. (7.2kg)
8606 3/8" x 75' Cable with Ferrule.....22 lbs. (10kg)
8607 3/8" x 100' Cable with Ferrule.....28 lbs. (12.7kg)
8608 3/8" x 150' Cable with Ferrule.....37 lbs. (16.8kg)
8610 Cable Grip – Double V7 lbs. (3kg)
8611 Cable Grip – Flat7 lbs. (3kg)
8625 3/4" Poly/Copper Pipe Pulling Attachment.....1 lb. (.25kg)
8626 1" Poly/Copper Pipe Pulling Attachment.....1 lb. (.25kg)



Poly/Copper Pipe Pulling Attachments

8601 PIPE SLICE with 1-1/2" – 12 Straight Threads, Single Blade.....3 lbs. (1.4kg)

Recommended for replacing existing poly service lines.

Kits:

8633 Includes 8601 Pipe Slice, 8610 Cable Grip, 8645 & 8646 Poly Pipe Pulling Attachments18 lbs. (8kg)
8634 Includes 8601 Pipe Slice, 8611 Cable Grip, 8645 & 8646 Poly Pipe Pulling Attachments18 lbs. (8kg)
8635 Includes 8601 Pipe Slice, 8610 Cable Grip, 8647 Flare Tool, 8648 & 8649 Copper Flare Locknuts.....18 lbs. (8kg)
8636 Includes 8601 Pipe Slice, 8611 Cable Grip, 8647 Flare Tool, 8648 & 8649 Copper Flare Locknuts.....18 lbs. (8kg)
8637 Includes 8601 Pipe Slice, 8610 Cable Grip, 8645 & 8646 Poly Pipe Pulling Attachments, 8647 Flare Tool, 8648 & 8649 Copper Flare Locknuts..20 lbs. (9kg)
8638 Includes 8601 Pipe Slice, 8611 Cable Grip, 8645 & 8646 Poly Pipe Pulling Attachments, 8647 Flare Tool, 8648 & 8649 Copper Flare Locknuts.. 20 lbs. (9kg)

Accessories:

8605 3/8" x 50' Cable with Ferrule.....16 lbs. (7.2kg)
8606 3/8" x 75' Cable with Ferrule.....22 lbs. (10kg)
8607 3/8" x 100' Cable with Ferrule.....28 lbs. (12.7kg)
8608 3/8" x 150' Cable with Ferrule.....37 lbs. (16.8kg)
8610 Cable Grip – Double V7 lbs. (3kg)
8611 Cable Grip – Flat7 lbs. (3kg)
8645 3/4" Poly Pipe Pulling Attachment1 lb. (.25kg)
8646 1" Poly Pipe Pulling Attachment1 lb. (.25kg)
8647 3/4" & 1" Double Flare Tool.....1 lb. (.5kg)
8648 3/4" Copper Flare Locknut.....1 lb. (.25kg)
8649 1" Copper Flare Locknut1 lb. (.25kg)



Poly Pipe Pulling Attachments



Double Flare Tool

Copper Flare Locknut

8500 MINI PIPE SLICE with 1/2" NPT Male Threads.....1 lb. (0.5kg)

Kits:

8520 Includes 8500 Mini Pipe Slice, 8506 50' Cable, 8525 Pulling Attachment, 8611 Cable Grip18 lbs. (8kg)
8521 Includes 8500 Mini Pipe Slice, 8507 75' Cable, 8525 Pulling Attachment, 8611 Cable Grip21 lbs. (9.5kg)
8522 Includes 8500 Mini Pipe Slice, 8508 100' Cable, 8525 Pulling Attachment, 8611 Cable Grip23 lbs. (10.5kg)

Accessories:

8506 1/4" x 50' Cable with Ferrule8 lbs. (3.6kg)
8507 1/4" x 75' Cable with Ferrule11 lbs. (5kg)
8508 1/4" x 100' Cable with Ferrule13 lbs. (6 kg)
8525 1/2" – 3/4" Pipe Pulling Attachment1 lb. (.25kg)



Mini Pipe Slice

VALVE EXERCISERS



VALVEMASTER PORTABLE VALVE EXERCISER

ValveMaster portable valve exerciser delivers 0–600 ft. lbs. of torque with finger tip control. All torque absorbed by frame to protect the operator. Standard features include digital counter, 2" ball hitch coupling, 4.80 x 12" wheels and auxiliary connections for use as hydraulic power source for other tools.

(Type II 8 gpm, 2000 psi) 8 ft telescoping key included

- 98001 With Honda engine 512 lbs. (233kg)
- 98003 With Honda engine and reversible counter..... 510 lbs. (232kg)

Note: 8 foot is the maximum key length recommended for optimal performance.

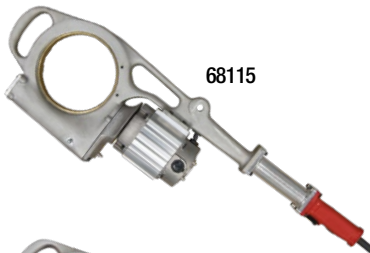

68115

VALVE EXERCISER / POWER DRIVE

The 68 series valve exerciser offers high performance in a compact, lightweight package. A wide variety of adapters are available for multiple uses. 115V, 1/2 hp., 6 amps, 250 ft. lbs., 22 RPM.

- 68115 Power Drive only – For use with adapters below 22 rpm.35 lbs. (15.90kg)
Other voltages may be available upon request.

- 681150 Power Drive with 13964, 22 rpm.....45 lbs. (20.45kg)

- 681155 Rising Stem Valve Operator with counter, clutch and hand wheel adapter
Weight62 lbs. (28.1kg)

- 68315 Power Drive Only, 66 rpm

- 683155 Power Drive with 13968 and 13970, 66 rpm

- 13964 Torque Limiting Adapter with counter and 1" square drive. 0-250 ft. lbs.
Weight8 lbs. (3.6kg)

- 10709 1" Square Female Adapter
Weight3 lbs. (1.4kg)

- 10696 Adapter for 12R drop head dies
Weight2 lbs. (0.9kg)

- 701061 Electric Counter Assembly
Weight1.5 lbs. (.65kg)

- 21389 Torque Limiting Adapter with 1" Square Drive, 2-250 ft. lbs.
Weight8 lbs. (3.6kg)

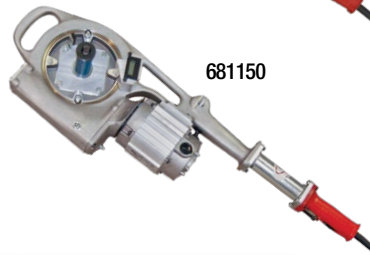

681150



681155



13964

10709

10696



681150 in use

ALUMINUM VALVE WHEEL WRENCHES

Designed to provide leverage to turn a valve wheel without slipping. Made from aluminum to be light weight and non-sparking. Three convenient sizes for added leverage.

- 8708 8" Length (3/4" Mouth Opening) Weight..... .03 lb. (0.13kg)
- 8714 14" Length (1" Mouth Opening) Weight 1 lb. (.45kg)
- 8718 18" Length (1 3/8" Mouth Opening) Weight..... 2.5 lbs. (1.1kg)





13968 RISING STEM TORQUE ADAPTER

Features:

- Clutch “slips” to keep operator and valve safe while exercising.
- Torque Specs: adjustable 0 – 200 ft.lbs.
- Unique clutch system allows you to set the torque accordingly, to exercise valves without exceeding their limit.
- Clutch can be easily adjusted with any 3/4" wrench. (Not included)
- Control Rods have graduations for approximate ft.lbs. of torque.
- To be used with the 13970 on rising stem valves.
- The 701061 counter assembly can be added to the 68115 and the 13970 for ease of valve revolution counting.
- Clutch is allowed to “slip” and keep correct count when using the 701061 counter assembly.

Weight10 lbs. (4.5kg)



13970 HAND WHEEL ADAPTER

Features:

- Adapts to valves with hand wheels with or without rising stems up to 3" in diameter.
- Series of bolt holes to adapt to many different spoke patterns and styles available.
- Allows you to exercise the valve with ease by using the 68115 with the addition of a 13968 Rising Stem Torque Adapter.
- The 701061 counter assembly can be added to the 68115 and the 13968 for ease of valve revolution counting.

Weight12 lbs. (5.45kg)



10700 HYDRANT NUT

A convenient 1" square drive adapter designed for most hydrants. Use it with a portable power drive or with a T-Handle Key. It reduces worker fatigue when used with the WHEELER-REX 68115 Power Drive. Can also use the WHEELER-REX 8806 or 8808 Telescoping Valve Keys.

Machined and fabricated steel construction, adjustable to a variety of pentagon nut up to a 1-3/4". A 3/4" jam bolt is included.

Weight6 lbs. (2.7kg)

VALVE KEYS

8806 6 FT. TELESCOPING VALVE KEY

Packed into a convenient 24" carrying case. Quick disconnect pull pins make adjustments fast and easy. Both a manual handle and a 1" square power adapter are included. 2" square female drive fits most standard valves. Telescopes to 6 ft.20 lbs. (9kg)

8808 8 FT. TELESCOPING VALVE KEY

Packed into a convenient 24" carrying case. Quick disconnect pull pins make adjustments fast and easy. Both a manual handle and a 1" square power adapter are included. 2" square female drive fits most standard valves. Telescopes to 8 ft.23 lbs. (10.5kg)

88024 2 FT. EXTENSION

To extend your 8806 6' key into an 8808 8' key5.5 lbs. (2.5kg)



WHEELER-REX 2'X2' GRID WALL DISPLAY



- 998042 Wall Display Kit 2'x2'
1 Black and 1 Red Panel,
18 hooks per kit
- 998043 Wall Display Literature Holder Accessory
- 998037 Counter Mat
- 998022 Product Catalog
- 998027 Price List
- 998039 Threading Machine Mini Catalog
- 998040 Test Pump Mini Catalog
- 998041 Tubing Cutter Mini Catalog



998042, 998043

998037



998022

998027



998039

998040



998041

WHEELER-REX HISTORY



Wheeler Manufacturing was established in 1957 on the shores of Lake Erie, with the invention of the chain-type snap cutter for cast iron and clay tile pipes. A product that would become the first of many industry changing inventions.

In 1988, Wheeler became part of the Rex Industries family. Rex Industries is known for the highest quality and most innovative pipe threading machines in the world. Rex set the bar for threading machine standards on a global scale with features such as through the die head oiling, auto open die heads, notch-style adjustment, and ball detent die location.

Thus, WHEELER-REX was born. Blending the best of American and Japanese culture to create a company focused on product perfection, work ethic, employee pride, and customer success. Today, WHEELER-REX maintains its presence as one of the industry leaders in the Hydrostatic Test Pump and Threading Machine markets. As well as continuing to focus on expanding our line of pipe tools, accessories, and exemplary customer service staff.

VISIT THE WHEELER-REX WEBSITE



WHEELER-REX products are sold exclusively through an extensive network of distributors. To find your nearest location, use the "Where to Buy" feature located on our website, or give us a call! Also available are online catalogs, product information, parts diagrams, operation manuals, and other useful information.



WHEELER-REX

PO Box 688, 3744 Jefferson Road, Ashtabula, Ohio 44005
Tel: (440) 998-2788 Toll Free: 1-800-321-7950 Fax: (440) 992-2925
www.wheelerrex.com | Email: wheeler@wheelerrex.com

ORDER NOW

Eastern Time 1-800-321-7950

Fax 440-992-2925

wheeler@wheelerrex.com

PRODUCT LISTING

| Part No | Description | Page |
|---------|---|------|
| 70 | SHUT OFF TOOL 1-1/4"-2" SOFT COPPER | 49 |
| 71 | ENGLISH/METRIC 6 FOOT DIAMETER TAPE | 47 |
| 75 | SHUT OFF TOOL 3/8"-2" PLASTIC WATER LINES | 49 |
| 77 | SHUT OFF TOOL 3/8"-2" PLASTIC GAS LINES | 49 |
| 85 | SHUT OFF TOOL 3/4"- 1" COPPER LINES | 49 |
| 86 | SHUT OFF TOOL 1/2"- 1" COPPER LINES | 49 |
| 450 | TUBE CLEANING BRUSH 1/2" & 3/4" COPPER | 20 |
| 452 | REPLACEMENT BRUSH SET (453 AND 454) | 20 |
| 522 | COMPLETE CHAIN FOR 6" 490/590 | 6 |
| 528 | COMPLETE CHAIN FOR 8" 590/490 | 6 |
| 532 | COMPLETE CHAIN FOR 6" 590/490 W/ROLLERS | 6 |
| 533 | COMPLETE CHAIN FOR 8" 590/490 W/ROLLERS | 6 |
| 600 | PLASTIC PIPE HAND SAW 18" | 13 |
| 601 | PLASTIC PIPE HAND SAW 18", PTFE BLADE | 13 |
| 602 | PLASTIC PIPE HAND SAW 13" | 13 |
| 603 | PLASTIC PIPE HAND SAW 13", PTFE BLADE | 13 |
| 610 | REPLACEMENT 18" BLADE FOR 600 SAW | 13 |
| 611 | REPLACEMENT 18" BLADE FOR 601 SAW | 13 |
| 612 | REPLACEMENT 13" BLADE FOR 602 SAW | 13 |
| 613 | REPLACEMENT 13" BLADE FOR 603 SAW | 13 |
| 626 | 26" CABLE SAW | 13 |
| 636 | 36" CABLE SAW | 13 |
| 640 | POWER DRIVE W/CASE, ADAPTER&TORQUE VISE | 26 |
| 841 | STAND FOR 7991 | 30 |
| 850 | FOLDING PIPE STAND W/ V HEAD | 42 |
| 851 | FOLDING PIPE STAND W/BT HEAD | 42 |
| 854 | BALL TRANSFER SET PAIR | 42 |
| 880 | PIPE DOLLIE 3"-30" | 43 |
| 892 | T-HANDLE GUILLOTINE CUTTER, POINTED | 16 |
| 919 | 5 PACK OF DEBURRING TOOLS | 22 |
| 921 | 10 PACK OF DEBURRING TOOLS | 22 |
| 925 | 50 PACK OF DEBURRING TOOLS | 25 |
| 940 | HD METRIC DS KIT-19,22,24MM | 47 |
| 941 | HD METRIC DS KIT-19,22,24,30MM | 47 |
| 942 | HD METRIC DS KIT-17,19,24,30MM | 47 |
| 943 | HD 19MM DEEP SOCKET | 47 |
| 944 | HD 22MM DEEP SOCKET | 47 |
| 945 | HD 24MM DEEP SOCKET | 47 |
| 946 | HD 30MM DEEP SOCKET | 47 |
| 947 | HD 17MM DEEP SOCKET | 47 |
| 948 | HD 27MM DEEP SOCKET | 47 |
| 950 | HD METRIC DS KIT-17,19,22,24,27,30 | 47 |
| 960 | HD DEEP SOCKET KIT-980,981,982 | 47 |
| 961 | HD DEEP SOCKET KIT-980,981,982,983 | 47 |
| 962 | HD DEEP SOCKET KIT-980,982,983 | 47 |
| 963 | HD DEEP SOCKET KIT-981,982,984,985 | 47 |
| 964 | HD DEEP SOCKET KIT-981,982,983 | 47 |
| 965 | HD DEEP SOCKET KIT-979,981,982 | 47 |
| 966 | HD DEEP SOCKET KIT-978,979,980,981 | 47 |
| 967 | HD DEEP SOCKET KIT (10 SOCKETS)978 THRU 987 | 47 |
| 968 | HD DEEP SOCKET KIT-978, 979,980,981,982,983 | 47 |
| 978 | 3/4 HD DEEP SOCKET | 47 |
| 979 | 7/8 HD DEEP SOCKET | 47 |
| 980 | 15/16 HD DEEP SOCKET | 47 |
| 981 | 1-1/16 HD DEEP SOCKET | 47 |

| Part No | Description | Page |
|---------|--|------|
| 982 | 1-1/4 HD DEEP SOCKET | 47 |
| 983 | 1-1/8 HD DEEP SOCKET | 47 |
| 984 | 1-5/16 HD DEEP SOCKET | 47 |
| 985 | 1-7/16 HD DEEP SOCKET | 47 |
| 986 | 1 HD DEEP SOCKET | 47 |
| 987 | 1-1/2 HD DEEP SOCKET | 47 |
| 1293 | REPLACEMENT BLADAE FOR MODELS 1590, 2290, 2492 | 15 |
| 1300 | PIPE SCRAPER, 3"-12" | 47 |
| 1350 | PIPE SCRAPER, 12"-36" | 47 |
| 1590 | INTERNAL PIPE CUTTER 1-1/2" | 15 |
| 1660 | HOLE CUTTER, GAS | 52 |
| 1661 | HOLE CUTTER, PNEUMATIC | 52 |
| 1662 | HOLE CUTTER, ELECTRIC | 52 |
| 1663 | HOLE CUTTER, HYDRAULIC | 52 |
| 1664 | HOLE CUTTER, LESS DRIVE | 52 |
| 1697 | T-HANDLE GUILLOTINE CUTTER 8", SS BLADE | 16 |
| 1755 | 3/8"- 2-3/8" FREEZE KIT W/ 2CANS SPRAY | 48 |
| 1894 | GUILLOTINE CUTTER/POWER DRIVEN | 16 |
| 1897 | GUILLOTINE CUTTER, 14.2", V BLADE, T-HANDLE | 16 |
| 1924 | COMPLETE CHAIN FOR 8" 2990 | 6 |
| 1926 | COMPLETE CHAIN FOR 6" 2990 | 6 |
| 1964 | FASTITE 5/16" SOCKET 60IN LB | 46 |
| 1965 | FASTITE 3/8" SOCKET 80IN LB | 46 |
| 1966 | FASTITE 5/16" SOCKET 80IN LB | 46 |
| 1977 | SOIL PIPE TORQUE WRENCH,60in/lb 5/16" | 46 |
| 1980 | SOIL PIPE TORQUE WRENCH,80IN/LB 5/16" | 46 |
| 1981 | SOIL PIPE TORQUE WRENCH,80IN/LB 3/8" | 46 |
| 1982 | SOIL PIPE TORQUE WRENCH,80IN/LB 5/16"& 3/8" | 46 |
| 2290 | INTERNAL PIPE CUTTER 2" | 15 |
| 2492 | INTERNAL PIPE CUTTER 2" SCH 80 | 15 |
| 2690 | 1/8"-2" STEEL PIPE CUTTER | 7 |
| 3090 | HOLE CUTTER W/MILW ADAPTER/NO DRILL | 51 |
| 3091 | HOLE CUTTER W/DEWALT ADAPTER/NO DRILL | 51 |
| 3092 | 3090 HOLE CUTTER W/MILW DRILL | 51 |
| 3093 | 3091 HOLE CUTTER W/DWLT DRILL | 51 |
| 3290 | INTERNAL PIPE CUTTER 3" | 15 |
| 3293 | REPLACEMENT BLADE FOR MODELS 3290 AND 3490 | 15 |
| 3490 | INTERNAL PIPE CUTTER 3" SCH 80 | 15 |
| 3590 | 1/8"-3/8" RATCH-CUT | 21 |
| 3790 | 5/16"-1-1/8" RATCH CUT | 21 |
| 3801 | WHEELER HYDROYL ONE QUART | 5 |
| 3804 | WHEELER HYDROYL ONE GALLON | 5 |
| 3824 | COMPLETE CHAIN 12" FOR 389012 | 6 |
| 4012 | PIPE PULLER 4" - 14" | 43 |
| 4160 | TRIPOD CHAIN VISE 1/8"-6" | 42 |
| 4180 | BENCH CHAIN VISE | 42 |
| 4190 | MICRO SNIPPER 1/4" TO 3/8" | 12 |
| 4200 | 1/2"-2" MANUAL THREADER SET, NPT | 26 |
| 4202 | 1/2"- 1" RATCHET THREADER SET, NPT | 26 |
| 4207 | 1/2-1-1/4" MANUAL THREADER SET, NPT | 26 |
| 4211 | 1"-2" MANUAL THREADER SET, NPT | 26 |
| 4213 | 1/2"-2" MANUAL THREADER SET, NPT, NO CASE | 26 |
| 4215 | 1/2-2"BSPT MANUAL THREADER SET, BSPT | 26 |
| 4290 | INTERNAL PIPE CUTTER 4" | 15 |
| 4293 | REPLACEMENT BLADE FOR 4290, 4490, 6000 | 15 |

| Part No | Description | Page |
|---------|---|------|
| 4310 | 10" GRIPMASTER PIPE WRENCH | 45 |
| 4314 | 14" GRIPMASTER PIPE WRENCH | 45 |
| 4410 | 10" ALUMINUM STRAIGHT PIPE WRENCH | 44 |
| 4414 | 14" ALUMINUM STRAIGHT PIPE WRENCH | 44 |
| 4418 | 18" ALUMINUM STRAIGHT PIPE WRENCH | 44 |
| 4424 | 24" ALUMINUM STRAIGHT PIPE WRENCH | 44 |
| 4436 | 36" ALUMINUM STRAIGHT PIPE WRENCH | 44 |
| 4448 | 48" ALUMINUM STRAIGHT PIPE WRENCH | 44 |
| 4490 | INTERNAL PIPE CUTTER 4" SCH 80 | 15 |
| 4506 | COPPER TUBE CLEANER (6-IN-1) 1/2"&3/4" | 20 |
| 4508 | 8"HD STRAIGHT IRON PIPE WRENCH | 44 |
| 4510 | 10" HD STRAIGHT IRON PIPE WRENCH | 44 |
| 4512 | 12" HD STRAIGHT IRON PIPE WRENCH | 44 |
| 4514 | 14" HD STRAIGHT IRON PIPE WRENCH | 44 |
| 4518 | 18" HD STRAIGHT IRON PIPE WRENCH | 44 |
| 4524 | 24" HD STRAIGHT IRON PIPE WRENCH | 44 |
| 4536 | 36" HD STRAIGHT IRON PIPE WRENCH | 44 |
| 4548 | 48" HD STRAIGHT IRON PIPE WRENCH | 44 |
| 4560 | 60" HD STRAIGHT IRON PIPE WRENCH | 44 |
| 4606 | 6" DIAMOND BLADE FOR DI & CI | 9 |
| 4612 | 12" SPUD WRENCH | 45 |
| 4616 | 6" DIAMOND ECONOMY BLADE | 9 |
| 4685 | SET OF 6 STEEL WEDGES | 8 |
| 4686 | ROLLER CHAIN, ONE LINK SECTION | 8 |
| 4690 | 2"-4" STEEL PIPE CUTTER | 7 |
| 4700 | HAMMERHEAD FLARING KIT, 3/4"-2" COPPER | 22 |
| 4706 | 6.5" TCT BLADE FOR STEEL | 9 |
| 4710 | 10" HD END IRON PIPE WRENCH | 44 |
| 4714 | 14" HD END IRON PIPE WRENCH | 44 |
| 4718 | 18" END IRON PIPE WRENCH | 44 |
| 4814 | 14" ALUMINUM OFF-SET PIPE WRENCH | 44 |
| 4818 | 18" ALUMINUM OFF-SET PIPE WRENCH | 44 |
| 4824 | 24" ALUMINUM OFF-SET PIPE WRENCH | 44 |
| 4900 | REROUNDING TOOL KIT 3/4"-2" COPPER | 22 |
| 4906 | RATCHET PIPE CTR 1-1/2 to 6 | 4 |
| 4908 | RATCHET PIPE CTR 1-1/2 to 8 | 4 |
| 4916 | RATCHET PIPE CUTTER 1-1/2"-6" W/519 | 4 |
| 4918 | RATCHET PIPE CUTTER 1-1/2"-8" W/519 | 4 |
| 4992 | CLOSE QUARTER CUTTER, COPPER&PLASTIC | 21 |
| 5090 | PIPE CUTTER 1/2"- 2" | 7 |
| 5190 | MINI SNIPPER 1/8" TO 1-1/4" | 11 |
| 5191 | MINI SNIPPER 1/8" TO 1-1/4", PTFE BLADE | 11 |
| 5195 | ECONOMY SNIPPER 1/8" - 1-1/4" | 12 |
| 5196 | REPLACEMENT BLADE FOR 5195 | 12 |
| 5200 | REPLACEMENT BLADE 5190 | 11 |
| 5210 | COMPLETE CHAIN, 10" 490/590 | 6 |
| 5212 | COMPLETE CHAIN, 12" 490/590 | 6 |
| 5215 | COMPLETE CHAIN, 15" 490/590 | 6 |
| 5256 | CHAIN EXTENSION 490/590 8 PINS | 6 |
| 5258 | CHAIN EXTENSION 490/590 14PINS | 6 |
| 5280 | V-BLADE RATCHET SNIPPER 1/8"-1 5/8" | 11 |
| 5291 | PROFESSIONAL SNIPPER 5291, 1/8"- 1-5/8" | 11 |
| 5295 | ECONOMY SNIPPER 1/8" - 1-5/8" | 12 |
| 5296 | REPLACEMENT BLADE FOR 5296 | 12 |
| 5299 | REPLACEMENT BLADE FOR 5191 | 11 |

| Part No | Description | Page |
|---------|---|-------|
| 5300 | REPLACEMENT BLADE FOR 5291 | 11 |
| 5400 | CHAIN WRENCH | 45 |
| 5412 | OPC,4-12" CUT & GRV STL & ALU | 25 |
| 5524 | COMPLETE CHAIN 18" FOR 559018 | 6 |
| 5350 | REPLACEMENT BLADE 5280 | 11 |
| 5624 | PIPEMASTER II, 6" - 24" | 8 |
| 5690 | AUTO C CUTTER 1/2" (15.9MM) | 21 |
| 5691 | AUTO C CUTTER 3/4" (22.2MM) | 21 |
| 5692 | AUTO C CUTTER 1" (28.6MM) | 21 |
| 5741 | RETRACTABLE UTILITY KNIFE | 18 |
| 5751 | SELF-RETRACTING SAFETY KNIFE | 18 |
| 5761 | 5 PACK OF REPLACEMENT KNIFE BLADES | 18 |
| 5800 | 3/4" CUTTER SHELL PLASTIC C-900 | 50 |
| 5801 | 1" CUTTER SHELL PLASTIC C-900 | 50 |
| 5803 | 1 1/4" CUTTER SHELL PLASTIC C-900 | 50 |
| 5900 | OIL BUCKET W/PUMP | 26 |
| 5906 | MANUAL PIPE CTR 1-1/2" to 6" | 4 |
| 5908 | MANUAL PIPE CTR 1-1/2 to 8 | 4 |
| 5916 | MANUAL CUTTER 1-1/2"-6", W/519 | 4 |
| 5918 | MANUAL PIPE CUTTER 1-1/2"-8", W/519 | 4 |
| 6000 | INTERNAL PIPE CUTTER 6" | 15 |
| 6154 | IPC KIT FOR 1 1/2", 2", 3", 4" | 15 |
| 6156 | IPC KIT FOR 1 1/2", 2", 3", 4", 6" | 15 |
| 6412 | OPMT CUT & BEVEL DIP 4"-12" | 25 |
| 6500 | HYDRAULIC POWER PACK | 9 |
| 6515 | RATCHET | 16,49 |
| 6590 | THREADING MACHINE 2-1/2"-6" | 29 |
| 6598 | THREADING MACHINE 2-1/2-6"220V | 29 |
| 6790 | THREADING MACHINE 1/2"-4" | 29 |
| 6793 | 6790 THREADING MACHINE 1/2"-4"(NOTCH DH) | 29 |
| 6794 | 6790 THREADING MACHINE 1/2"-4"(BLADE CTR) | 29 |
| 6798 | THREADING MACHINE 1/2"-4" 220V | 29 |
| 7280 | V-BLADE RATCHET SNIPPER 1/8"-2 7/16" | 11 |
| 7291 | PROFESSIONAL SNIPPER 7291 1/8"- 2-7/16" | 11 |
| 7324 | REPLACEMENT BLADE FOR 7291 | 11 |
| 7350 | REPLACEMENT BLADE FOR 7280 | 11 |
| 7702 | ROLL GROOVING MACHINE W/MANUAL PUMP | 25 |
| 7703 | ROLL GROOVING MACHINE W/POWER PUMP | 25 |
| 7800 | EARTHWORM HYDRO DRILL | 52 |
| 7801 | 1 INCH AUGER | 52 |
| 7802 | 2 INCH AUGER | 52 |
| 7808 | 4 INCH REVERSE AUGER | 52 |
| 7809 | 6 INCH REVERSE AUGER | 52 |
| 7810 | 3 INCH AUGER | 52 |
| 7914 | 3/8 PITCH CUTTER CHAIN | 10 |
| 7922 | 1-1/2" GLASS CUTTER CHAIN, 3/8 PITCH | 10 |
| 8001 | CUTTER WHEEL | 7 |
| 8003 | CUTTER WHEEL | 23 |
| 8004 | CUTTER WHEEL - 4690 (8016) | 7 |
| 8006 | CUTTER WHEEL | 23 |
| 8012 | CUTTER WHEEL | 23 |
| 8015 | CUTTER WHEEL | 23 |
| 8021 | CUTTER WHEEL | 23 |
| 8025 | CUTTER WHEEL | 23 |
| 8033 | CUTTER WHEEL FOR PLASTIC 4992 | 21 |

ORDER NOW

Eastern Time 1-800-321-7950

Fax 440-992-2925

wheeler@wheelerrex.com

PRODUCT LISTING

| Part No | Description | Page |
|---------|---|------|
| 8034 | CUTTER WHEEL | 23 |
| 8037 | CUTTER WHEEL | 23 |
| 8038 | CUTTER WHEEL, 4990/ 4991/4992 | 21 |
| 8039 | CUTTER WHEEL, 5090 | 7 |
| 8040 | CUTTER WHEEL FOR 2590/3590, RC375 | 21 |
| 8041 | CUTTER WHEEL FOR 2790/3790, RC1125 | 23 |
| 8042 | CUTTER WHEEL FOR 4590 | 23 |
| 8043 | CUTTER WHEEL FOR 4790 | 23 |
| 8044 | CUTTER WHEEL FOR 2790 & 3790 HSS/SS | 21 |
| 8045 | CUTTER WHEEL | 23 |
| 8046 | CUTTER WHEEL FOR 5690/1/2,COPPER/CTS/CPVC | 21 |
| 8050 | CUTTER WHEEL FOR 95041 STEEL, STYLE HS4 | 7 |
| 8051 | CUTTER WHEEL FOR 95041 CI/DI, STYLE H14 | 7 |
| 8052 | CUTTER WHEEL FOR 95061 STEEL, STYLE HS6 | 7 |
| 8053 | CUTTER WHEEL FOR 95061/81/121, CI/DI | 7 |
| 8054 | CUTTER WHEEL FOR 95081/121 STL | 7 |
| 8066 | CUTTER WHEEL FOR 90748,90749, PLASTIC | 20 |
| 8067 | CUTTER WHEEL FOR 90748,90749, COPPER,AL | 20 |
| 8068 | CUTTER WHEEL FOR 90747, PLASTIC | 19 |
| 8069 | CUTTER WHEEL (90710/721/727/734/747) | 19 |
| 8071 | CUTTER WHEEL FOR 90735/90728/90750 METAL | 23 |
| 8073 | CUTTER WHEEL FOR 90750 PLASTIC | 23 |
| 8074 | CUTTER WHEEL FOR 90737,90751 PLASTIC | 23 |
| 8075 | CUTTER WHEEL FOR 90738, 90752 PLASTIC | 23 |
| 8076 | CUTTER WHEEL FOR 95061/81/121,UNIVERSAL | 7 |
| 8082 | CUTTER WHEEL FOR 2690 SS | 7 |
| 8090 | THREADING MACHINE 1/2"-2" | 28 |
| 8096 | THREADER 8090 W/2 DIE HEADS | 28 |
| 8097 | THREADER 8090 W/897065 DH | 28 |
| 8098 | THREADING MACHINE 1/2"-2" 220V | 28 |
| 8100 | HOT TAPPING SYSTEM 3/4"-1" NPT, STEEL/COPPER | 50 |
| 8102 | HOT TAPPING SYSTEM 3/4"-2" NPT, STEEL/COPPER | 50 |
| 8200 | HOT TAPPING SYSTEM 3/4"-1" CTS, STEEL/COPPER | 50 |
| 8201 | HOT TAPPING SYSTEM 3/4"-1" CTS, PLASTIC | 50 |
| 8202 | HOT TAPPING SYSTEM 3/4"-2" CTS, PLASTIC | 50 |
| 8203 | HOT TAPPING SYSTEM 3/4"-1" CTS, DI & CI | 50 |
| 8204 | HOT TAPPING SYSTEM 3/4"-2" CTS, DI & CI | 50 |
| 8205 | HOT TAPPING SYSTEM 3/4"-1" CTS, PLASTIC, DI, CI | 50 |
| 8206 | HOT TAPPING SYSTEM 3/4"-2" CTS, PLASTIC, DI, CI | 50 |
| 8209 | HOT TAPPING SYSTEM 3/4"-2" CTS, PLASTIC, DI, CI | 50 |
| 8300 | HOT TAPPING SYSTEM 3/4"-1"BSPT, STEEL, COPPER | 50 |
| 8312 | 12" STRAP WRENCH, 1/2-2" PIPE | 45 |
| 8318 | 18" STRAP WRENCH, 1-5" PIPE | 45 |
| 8324 | 24" STRAP WRENCH, 2-12" PIPE | 45 |
| 8400 | ROLL GROOVER-6090,7090,8090 | 24 |
| 8401 | ROLL GROOVER-300 | 24 |
| 8402 | ROLL GROOVER FOR 300 COMPACT | 24 |
| 8403 | ROLL GROOVER 6790 | 24 |
| 8412 | OPMT CUT BEVEL STEEL 4"-12" | 25 |
| 8500 | MINI PIPE SLICE-PIPELINEREPLACEMENT TOOL | 53 |
| 8506 | 1/4 X 50' CABLE FOR MINI SLICE | 53 |
| 8507 | 1/4 X 75' CABLE FOR MINI SLICE | 53 |
| 8508 | 1/4 X 100' CABLE FOR MINI SLICE | 53 |
| 8520 | MINISLICE 50'-8506,8500,8611 | 53 |
| 8521 | MINISLICE 75'-8507,8500,8611 | 53 |

| Part No | Description | Page |
|---------|---|------|
| 8522 | MINISLICE 100'-8508,8500,8611 | 53 |
| 8525 | 1/2-3/4 POLY PULLER | 53 |
| 8570 | SHUT OFF TOOL COMBO 85 & 70, 3/4"-2" | 49 |
| 8600 | PIPE SLICE | 53 |
| 8601 | PIPESLICE II-PIPELINE REPLACEMENT TOOL | 53 |
| 8605 | 3/8 x 50' CABLE WITH FERRULE | 53 |
| 8606 | 3/8 x 75' CABLE WITH FERRULE | 53 |
| 8607 | 3/8 x 100' CABLE WITH FERRULE | 53 |
| 8608 | 3/8 x 150' CABLE WITH FERRULE | 53 |
| 8610 | CABLE GRIP - DOUBLE V | 53 |
| 8611 | CABLE GRIP - FLAT | 53 |
| 8625 | 3/4 POLY/COPPER PIPE PULLING FOR 8600 | 53 |
| 8626 | 1" POLY/COPPER PIPE PULLING FOR 8600 | 53 |
| 8631 | PIPE SLICE KIT 8600 SLICE, 8610 GRIP, 8625 & 8626 POLY/COPPER PULLING | 53 |
| 8632 | PIPE SLICE KIT 8600 SLICE, 86110 GRIP, 8625 & 8626 POLY/COPPER PULLING | 53 |
| 8633 | PIPE SLICE KIT 8601 SLICE, 8610 GRIP, 8645 & 8646 POLY PULLING ATTACHMENT | 53 |
| 8634 | PIPE SLICE KIT 8601 SLICE, 8611 GRIP, 8645 & 8646 POLY PULLING ATTACHMENT | 53 |
| 8635 | PIPE SLICE KIT 8601 SLICE, 8610 GRIP, 8647 FLARE, 8648 & 8649 LOCKNUT | 53 |
| 8636 | PIPE SLICE KIT 8601 SLICE, 8611 GRIP, 8645 & 8646 POLY PULLING ATTACHMENT | 53 |
| 8637 | PIPE SLICE KIT 8601, 8610, 8645, 8646, 8647, 8648, 8649 | 53 |
| 8638 | PIPE SLICE KIT 8601, 8611, 8645, 8646, 8647, 8648, 8649 | 53 |
| 8645 | 3/4 PE PIPE PULLING ATTACHMENT FOR 8601 | 53 |
| 8646 | 1" PE PULLER ATTACHMENT FOR 8601 | 53 |
| 8647 | 3/4"+ 1" DOUBLE FLARE TOOL FOR 8601 | 53 |
| 8648 | 3/4" COPPER FLARE LOCKNUT FOR 8601 | 53 |
| 8649 | 1" COPPER FLARE LOCKNUT FOR 8601 | 53 |
| 8670 | SHUT OFF TOOL COMBO 86 & 70 1/2"-2" | 49 |
| 8700 | FORGED HYDRANT WRENCH | 46 |
| 8708 | 8" ALUMINUM VALVE WHEEL WRENCH | 54 |
| 8714 | 14" ALUMINUM VALVE WHEEL WRENCH | 54 |
| 8718 | 18" ALUMINUM VALVE WHEEL WRENCH | 54 |
| 8806 | 6 FT ADJUST-A-KEY | 55 |
| 8808 | 8 FT ADJUST-A-KEY | 55 |
| 8900 | SLIK-TAP DIRECT TAP LUBRICANT | 51 |
| 8901 | SLIK-TAP, 12 PACK CASE | 51 |
| 8991 | THREADING MACHINE 1/2"-1" | 27 |
| 8992 | THREADER 8991 W/60131 DH | 27 |
| 8993 | THREADER 8991 W/2 DIE HEADS | 27 |
| 8998 | THREADING MACHINE 1/2"-1" 220V | 27 |
| 9000 | POWER PLASTIC BEVELER | 13 |
| 9001 | MODEL 9000 WITH CARBIDE BIT | 13 |
| 9015 | PLASTIC PIPE BEVEL TOOL | 13 |
| 9400 | TELESCOPING BASIN WRENCH | 45 |
| 9401 | STANDARD BASIN WRENCH | 45 |
| 9600 | 1-1/4 X 1-1/16 DOUBLE-UP WRENCH | 46 |
| 9601 | 15/16 X 1 1/8 DOUBLE-UP WRENCH | 46 |
| 9700 | HYDRAULIC ROLL GROOVER W/BASE FOR 60/70/8090 | 24 |
| 9701 | HYDRAULIC ROLL GROOVER W/BASE FOR 6790 | 24 |

| Part No | Description | Page |
|---------|---|------|
| 9703 | HYDRAULIC ROLL GROOVER W/BASE FOR 300 | 24 |
| 10050 | 1/2" CTS CHAMFER/BEVEL TOOL/DEPTH GAUGE | 15 |
| 10075 | 3/4" CTS CHAMFER/BEVEL TOOL/DEPTH GAUGE | 15 |
| 10100 | 1" CTS CHAMFER/BEVEL TOOL/DEPTH GAUGE | 15 |
| 10125 | 1-1/4" CTS CHAMFER/BEVEL TOOL/DEPTH GAUGE | 15 |
| 10150 | 1-1/2" CTS CHAMFER/BEVEL TOOL/DEPTH GAUGE | 15 |
| 10200 | 2" CTS CHAMFER/BEVEL TOOL/DEPTH GAUGE | 15 |
| 10696 | ADAPTER FOR 12R DROP HEAD DIES | 54 |
| 10700 | HYDRANT NUT DRIVER | 55 |
| 10709 | 1" SQUARE FEMALE ADAPTER | 54 |
| 13020 | 2" HINGED PIPE VISE | 43 |
| 13040 | 2-1/2" HINGED PIPE VISE | 43 |
| 13060 | 4" HINGED PIPE VISE | 43 |
| 13080 | 5" HINGED PIPE VISE | 43 |
| 13964 | TORQUE LIMITING ADAPTER W/CTR/1" SQ DRIVE | 54 |
| 13968 | RISING STEM TORQUE ADAPTER | 55 |
| 13970 | RISING STEM HAND WHEEL ADAPTER, 681155 | 55 |
| 16010 | 1.5"-4" PIPE HOG KIT Sch 40 | 14 |
| 16150 | 1-1/2" PIPE HOG | 14 |
| 16200 | 2" PIPE HOG | 14 |
| 16300 | 3" PIPE HOG | 14 |
| 16400 | 4" PIPE HOG | 14 |
| 16050 | 12" EXTENSION SHAFT | 14 |
| 16055 | 1/2" SQUARE CARBIDE INSERT | 14 |
| 17500 | REPLACEMENT POLAR GAS CANISTER | 48 |
| 19010 | CHAIN EXTENSION 8 PINS 2990 | 6 |
| 19012 | CHAIN EXTENSION 14 PINS 2990 | 6 |
| 19015 | CHAIN EXTENSION 20 PINS 2990 | 6 |
| 19020 | FITTING SAVER KIT IPS SCH 40 | 14 |
| 19025 | FITTING SAVER KIT IPS SCH 80 | 14 |
| 19030 | 1/2" CTS FITTING SAVER | 14 |
| 19035 | 3/4" CTS FITTING SAVER | 14 |
| 19050 | 1/2" SCH 40 FITTING SAVER | 14 |
| 19051 | 1/2" SCH 80 FITTING SAVER | 14 |
| 19075 | 3/4" SCH 40 FITTING SAVER | 14 |
| 19076 | 3/4" SCH 80 FITTING SAVER | 14 |
| 19100 | 1" SCH 40 FITTING SAVER | 14 |
| 19101 | 1" SCH 80 FITTING SAVER | 14 |
| 21389 | TORQUE LIMITING ADAPTER W/ 1" SQ DRIVE | 54 |
| 29200 | MANUAL TEST PUMP 300PSI | 36 |
| 29201 | MANUAL TEST PUMP 1000PSI | 36 |
| 29900 | MANUAL TEST PUMP W/TANK 870PSI | 36 |
| 29906 | 2-6" HYDRAULIC PIPE CUTTER | 5 |
| 29908 | 2-8" HYDRAULIC PIPE CUTTER | 5 |
| 30050 | 1/2" IPS CHAMFER/BEVELTOOL/DEPTH GAUGE | 15 |
| 30075 | 3/4" IPS CHAMFER/BEVEL TOOL/DEPTH GAUGE | 15 |
| 30100 | 1" IPS CHAMFER/BEVEL TOOL/DEPTH GAUGE | 15 |
| 30125 | 1-1/4" IPS CHAMFER/BEVEL TOOL/DEPTH GAUGE | 15 |
| 30150 | 1-1/2" IPS CHAMFER/BEVEL TOOL/DEPTH GAUGE | 15 |
| 30200 | 2" IPS CHAMFER/BEVEL TOOL/DEPTH GAUGE | 15 |
| 32150 | PNEUMATIC TEST PUMP, 1GPM/1500PSI | 40 |
| 32300 | PNEUMATIC TEST PUMP, .5GPM / 3000PSI | 40 |
| 32301 | FLUID SECTION REPAIR KIT FOR 32300 | 40 |
| 32450 | PNEUMATIC TEST PUMP, 1GPM, 10,000PSI | 40 |
| 32900 | 3" CAPITOL STYLE CI CUTTER | 7 |

| Part No | Description | Page |
|---------|--|------|
| 32964 | 4" DRIVE SHAFT FOR 1 1/2" - 2" MODELS | 15 |
| 33100 | ELECTRIC TEST PUMP 1000PSI, 1GPM | 39 |
| 33101 | ELECTRIC TEST PUMP (33100) 220V, 50HZ | 39 |
| 33110 | ELECTRIC TEST PUMP 1000 PSI, 1 GPM (COMET PUMP) | 39 |
| 35100 | ELECTRIC TEST PUMP 500PSI 3GPM | 39 |
| 35101 | ELECTRIC TEST PUMP 220V 50HZ | 39 |
| 36200 | TEST PUMP,3.5GPM, 1200PSI, B&S ENGINE | 37 |
| 36454 | HYDROSTATIC TEST PUMP 400PSI, 10GPM | 37 |
| 37210 | ELECTRIC TEST PUMP 3000 PSI3.5 GPM,208/230V 3-PHASE | 39 |
| 39300 | TEST PUMP 300PSI 4GPM 1/2HP | 39 |
| 39301 | 39300 TEST PUMP,220V,60HZ | 39 |
| 39906 | HD RATCHET PIPE CUTTER 6" | 4 |
| 39908 | HD RATCHET PIPE CUTTER 8" | 4 |
| 42900 | 4" CAPITOL STYLE CI CUTTER | 7 |
| 46200 | HYDROSTATIC TEST PUMP 1200PSI 3.5GPM B&S | 37 |
| 46301 | HYDROSTATIC TEST PUMP 300PSI 5.4GPM B&S | 37 |
| 46453 | HYDROSTATIC TEST PUMP 400PSI 10GPM | 37 |
| 46501 | HYDROSTATIC TEST PUMP 500PSI, 10GPM UDOR/B&S/ CART | 38 |
| 46503 | HYDROSTATIC TEST PUMP 500PSI, 10GPM UDOR/B&S/ ROLL CAGE | 38 |
| 46521 | HYDROSTATIC TEST PUMP 500PSI, 10GPM COMET/B&S/ CART | 38 |
| 46523 | HYDROSTATIC TEST PUMP 500PSI 10GPM COMET/B&S/ ROLL CAGE | 38 |
| 46600 | HYDROSTATIC TEST PUMP 300PSI, 15GPM B&S | 38 |
| 47100 | HYDROSTATIC TEST PUMP 1000PSI, ELECTRIC 115V 60HZ 2.2GPM | 39 |
| 47101 | HYDROSTATIC TEST PUMP 1000PSI, ELECTRIC 220V 50HZ 2.2GPM | 39 |
| 47102 | HYDROSTATIC TEST PUMP 2000PSI, ELECTRIC 115V 60HZ 1.1GPM | 39 |
| 47103 | HYDROSTATIC TEST PUMP 2000PSI, ELECTRIC 220V 50HZ 1.1GPM | 39 |
| 47105 | HYDROSTATIC TEST PUMP 2000PSI, ELECTRIC 115V 60HZ 2.2GPM | 39 |
| 49010 | RATCHET PIPE CTR 1-1/2" to 10" | 4 |
| 49012 | RATCHET PIPE CTR 1-1/2" to 12" | 4 |
| 49015 | RATCHET PIPE CUTTER 2"-15" | 4 |
| 49075 | REROUNDING TOOL 3/4" | 22 |
| 49100 | REROUNDING TOOL 1" | 22 |
| 49150 | REROUNDING TOOL 1-1/2" | 22 |
| 49200 | REROUNDING TOOL 2" | 22 |
| 50100 | INNER-OUTER REAMER 3/8"-2" 10MM-54MM | 22 |
| 52510 | CHAIN EXTENSION 490/590 20 PINS 6" | 6 |
| 52512 | CHAIN EXTENSION 490/590 26 PINS 8" | 6 |
| 56200 | 2 INCH TRASH PUMP | 41 |
| 56201 | 56200 WITH WHEELED CART | 41 |
| 56300 | 3 INCH TRASH PUMP | 41 |
| 56301 | 56300 WITH WHEELED CART | 41 |
| 56310 | 3" MUDSUCKER DIAPHRAGM PUMP | 41 |
| 59010 | MANUAL PIPE CUTTER 1-1/2"-10" | 4 |
| 59012 | MANUAL PIPE CUTTER 1-1/2"-12" | 4 |
| 59015 | MANUAL PIPE CUTTER 2"-15" | 4 |
| 60506 | WHEELED CART FOR 6390/6790 | 30 |

PRODUCT LISTING

| Part No | Description | Page |
|---------|---|--------|
| 60507 | WHEELED CART W/TOOL BOX, 6390/6790 | 30 |
| 60513 | COLLAPSIBLE CART FOR 8090 | 30 |
| 60514 | WHEELED CART FOR 6590 | 30 |
| 60515 | WHEEL CART W/TOOLBOX FOR 6590 | 30 |
| 60518 | ANTI-TIP BRACKET FOR COLLAPSIBLE CART | 30 |
| 60601 | THREADMASTER OIL GALLON JUG | 30 |
| 60602 | THREADMASTER OIL 5 GALLON PAIL | 30 |
| 60603 | THREADMASTER OIL 2 QUART BOTTLE | 30 |
| 60604 | THREADMASTER OIL 1 QUART BOTTLE | 30 |
| 60607 | THREADMASTER SS OIL 1 GALLON | 30 |
| 60608 | THREADMASTER SS OIL 5 GALLON | 30 |
| 60655 | THREADMASTER OIL 55 GALLON DRUM | 30 |
| 62000 | NIPPLE ATTACHMENT NPT 1/2" | 30 |
| 62001 | NIPPLE ATTACHMENT NPT 3/4" | 30 |
| 62002 | NIPPLE ATTACHMENT NPT 1" | 30 |
| 62003 | NIPPLE ATTACHMENT NPT 1-1/4" | 30 |
| 62004 | NIPPLE ATTACHMENT NPT 1-1/2" | 30 |
| 62005 | NIPPLE ATTACHMENT NPT 2" | 30 |
| 62006 | NIPPLE ATTACHMENT NPT 2-1/2" | 30 |
| 62007 | NIPPLE ATTACHMENT NPT 3" | 30 |
| 62009 | NIPPLE ATTACHMENT NPT 4" | 30 |
| 68115 | POWER DRIVE 22rpm, 115v, 50/60HZ, 1/2HP | 54 |
| 68315 | POWER DRIVE 66rpm, 115v, 50/60HZ, 1/2HP | 54 |
| 69012 | GLASS TUBE CUTTER 1/4"-3/4" | 10 |
| 79014 | GLASS TUBE CUTTER 1/4"-1" | 10 |
| 79022 | GLASS TUBE CUTTER 1/4"-1-1/2" | 10 |
| 80711 | REPLACEMENT DEBURRING BLADE | 19, 22 |
| 86075 | 3/4 CC PVC DRILL TAP | 51 |
| 86100 | 1 CC PVC DRILL TAP | 51 |
| 88024 | 2 FOOT KEY EXTENSION | 55 |
| 89075 | 3/4" DRILL TAP | 51 |
| 89100 | 1" DRILL TAP | 51 |
| 89150 | 1-1/2" DRILL TAP | 51 |
| 89200 | 2" DRILL TAP | 51 |
| 89202 | 1/2" PEX RING CRIMPER | 17 |
| 89203 | 3/4" PEX RING CRIMPER | 17 |
| 89204 | 1" PEX RING CRIMPER | 17 |
| 89206 | 1/2" & 3/4" PEX COMBO CRIMPER | 17 |
| 89210 | 1/2"- 1" RING REMOVER | 17 |
| 89211 | CLAMP REMOVAL TOOL | 18 |
| 89215 | 1/2" CLOSE QTRS CRIMP TOOL | 18 |
| 89216 | 3/4" CLOSE QTRS CRIMP TOOL | 18 |
| 89217 | COMBO CLAMP STYLE CRIMPER | 18 |
| 89250 | SS CLAMP PINCHER | 17 |
| 90710 | TUBING CUTTER 1/8"-1-1/8", CU/AL | 19 |
| 90721 | MINI TUBING CUTTER 1/8"-1", CU/AL | 19 |
| 90724 | MINI TUBING CUTTER 1/8"-1-1/8", SS | 20 |
| 90727 | MINI TUBING CUTTER 1/8"-1-1/8", CU/AL | 19 |
| 90730 | TUBING CUTTER 1/8"-1-3/4" SS | 20 |
| 90734 | TUBING CUTTER 1/8"-1-3/8", TELESCOPIC | 19 |
| 90747 | TUBING CUTTER 1/4"-3" QUICK RELEASE | 19 |
| 90748 | TUBING CUTTER 2"-5" QUICK RELEASE | 20 |
| 90749 | TUBING CUTTER 4"-6-5/8" QUICK RELEASE | 20 |
| 90764 | TUBING CUTTER 1/4"-3" SS | 20 |

| Part No | Description | Page |
|---------|--|------|
| 90799 | REPLACEMENT CUTTER WHEEL FOR SS TUBING CUTTERS | 20 |
| 95121 | HINGED PIPE CUTTER 8"-12" | 7 |
| 95240 | HINGED PIPE CUTTER 2"-4" | 7 |
| 95460 | HINGED PIPE CUTTER 4"-6" | 7 |
| 95680 | HINGED PIPE CUTTER 6"-8" | 7 |
| 98001 | ValveMaster Frwd Ctr Honda | 54 |
| 98003 | ValveMaster 2 way Ctr Honda | 54 |
| 192410 | COMPLETE CHAIN 10" FOR 299010 | 6 |
| 192412 | COMPLETE CHAIN 12" FOR 299012 | 6 |
| 192415 | COMPLETE CHAIN 15" FOR 299015 | 6 |
| 220220 | BEVELER UNIT LESS ROUTER | 13 |
| 220234 | REPLACEMENT HSS 15 DEGREE ROUTER BIT ASSEMBLY | 13 |
| 220041 | REPLACEMENT CARBIDE 15 DEGREE ROUTER BIT ASSEMBLY | 13 |
| 220083 | REPLACEMENT BLADE BEVEL FOR 9015 | 12 |
| 276288 | FLAT FACE MALE QUICK DISCONNECT | 8 |
| 276289 | FLAT FACE FEMALE QUICK DISCONNECT | 8 |
| 276693 | WATER SUPPLY TANK, 4 GALLON | 8 |
| 277227 | SCREW FOR CARBIDE CUTTING INSERT | 14 |
| 277228 | CARBIDE CUTTING INSERT | 14 |
| 299010 | 2-10" HYDRAULIC PIPE CUTTER | 5 |
| 299012 | 2-12" HYDRAULIC PIPE CUTTER | 5 |
| 299015 | 2-15" HYDRAULIC PIPE CUTTER | 5 |
| 362000 | HYDROSTATIC TEST PUMP, 3.5GPM 1200PSI HONDA | 37 |
| 363020 | FIRE HOSE TEST PUMP - 2 HOSE | 40 |
| 363040 | FIRE HOSE TEST PUMP - 4 HOSE | 40 |
| 363060 | GAS FIRE HOSE TEST PUMP 10GPM, 400PSI | 40 |
| 364540 | HYDROSTATIC TEST PUMP WITH HONDA ENGINE | 37 |
| 373080 | HYDROSTATIC TEST PUMP HONDA, 3.5GPM/3000PSI | 37 |
| 382415 | COMPLETE CHAIN 15" FOR 389015 | 6 |
| 382418 | COMPLETE CHAIN 18" FOR 389018 | 6 |
| 382424 | COMPLETE CHAIN 24" FOR 389024 | 6 |
| 382515 | CHAIN EXTENSION 8 PINS 3890 | 6 |
| 382518 | CHAIN EXTENSION 14 PINS 3890 | 6 |
| 382520 | CHAIN EXTENSION 20 PINS 3890 | 6 |
| 382524 | CHAIN EXTENSION 26 PINS 3890 | 6 |
| 389012 | 4"-12" HYDRAULIC PIPE CUTTER | 5 |
| 389015 | 4"-15" HYDRAULIC PIPE CUTTER | 5 |
| 389018 | 4"-18" HYDRAULIC PIPE CUTTER | 5 |
| 389024 | 4"-24" HYDRAULIC PIPE CUTTER | 5 |
| 401500 | PIPE VISE W/LEGS 3/4"-15" | 43 |
| 402000 | PIPE VISE W/LEGS 3/4"-20" | 43 |
| 402800 | PIPE VISE W/LEGS 3/4"-28" | 43 |
| 462000 | HYDROSTATIC TEST PUMP 1200PSI, 3.5GPM HONDA ENGINE | 37 |
| 463010 | HYDROSTATIC TEST PUMP 300PSI, 5.4GPM HONDA ENGINE | 37 |
| 464530 | HYDROSTATIC TEST PUMP 400PSI, 10GPM HONDA ENGINE | 37 |
| 465010 | HYDROSTATIC TEST PUMP 500PSI, 10GPM UDOR/HONDA/CART | 38 |
| 465030 | HYDROSTATIC TEST PUMP 500PSI, 10GPM UDOR/HONDA/ROLL CAGE | 38 |
| 465210 | HYDROSTATIC TEST PUMP 500PSI, 10GPM COMET/HONDA/CART | 38 |
| 465230 | HYDROSTATIC TEST PUMP 500PSI, 10GPM COMET/HONDA/CAGE | 38 |

| Part No | Description | Page |
|---------|---|------|
| 466000 | HYDROSTATIC TEST PUMP 300PSI, 15GPM HONDA ENGINE | 38 |
| 468260 | HYDROSTATIC TEST PUMP 300PSI, 32GPM HONDA ENGINE | 38 |
| 475200 | BAND SAW BLADE-ALLOY 8 TEETH | 25 |
| 475201 | BAND SAW BLADE- ALLOY 10 TEETH | 25 |
| 475202 | BAND SAW BLADE- ALLOY 14 TEETH | 25 |
| 475203 | BAND SAW BLADE- ALLOY 18 TEETH | 25 |
| 475204 | BAND SAW BLADE- ALLOY 24 TEETH | 25 |
| 475210 | BAND SAW BLADE - BI METAL 10 TEETH | 25 |
| 475211 | BAND SAW BLADE - BI METAL 14 TEETH | 25 |
| 475212 | BAND SAW BLADE - BI METAL 18 TEETH | 25 |
| 475213 | BAND SAW BLADE - BI METAL 24 TEETH | 25 |
| 506032 | SOCKET | 16 |
| 552420 | COMPLETE CHAIN 20" FOR 559020 | 6 |
| 552424 | COMPLETE CHAIN 24" FOR 559024 | 6 |
| 552436 | COMPLETE CHAIN 36" FOR 559036 | 6 |
| 552520 | CHAIN EXTENSION 4 PINS 5590 | 6 |
| 552524 | CHAIN EXTENSION 10 PINS 5590 | 6 |
| 552536 | CHAIN EXTENSION 28 PINS 5590 | 6 |
| 559018 | 6"-18" HYDRAULIC PIPE CUTTER | 5 |
| 559020 | 6"-20" HYDRAULIC PIPE CUTTER | 5 |
| 559024 | 6"-24" HYDRAULIC PIPE CUTTER | 5 |
| 559036 | 6"-36" HYDRAULIC PIPE CUTTER | 5 |
| 562000 | 2" TRASH PUMP W/HONDA ENGINE | 41 |
| 562001 | SAME AS 562000 WITH WHEELED CART | 41 |
| 563000 | 3" TRASH PUMP W/HONDA ENGINE | 41 |
| 563001 | SAME AS 563000 WITH WHEELED CART | 41 |
| 563100 | 3" MUDSUCKER DIAPHRAGM PUMP/HONDA | 41 |
| 681150 | POWER DRIVE W/CLUTCH & COUNTER, 250FT LBS 22RPM 115V 6 AMPS | 54 |
| 681155 | HAND WHEEL VALVE EXERCISER W/COUNTER & TORQUE ADAPTER, 22RPM | 54 |
| 683155 | HAND WHEEL VALVE EXERCISER W/COUNTER & TORUQE ADAPTER, 66RPM | 54 |
| 690012 | COMPLETE CHAIN FOR 69012 GLASS CUTTER | 10 |
| 700155 | REPLACEMENT BLADE FOR ALL CHAMFERING TOOLS | 15 |
| 700536 | VACUUM TEST ASSEMBLY | 41 |
| 700588 | SCHEDULE 80 GUIDE FOR 16150 | 14 |
| 700589 | SCHEDULE 80 GUIDE FOR 16200 | 14 |
| 700590 | SCHEDULE 80 GUIDE FOR 16300 | 14 |
| 700591 | SCHEDULE 80 GUIDE FOR 16400 | 14 |
| 700692 | REPLACEMENT STRAIGHT BLADE PFTE COATED | 16 |
| 700777 | 6" DRIVE SHAFT FOR 1 1/2" - 2" MODELS | 15 |
| 700778 | 6" DRIVE SHAFT FOR 3", 4" AND 6" MODELS | 15 |
| 700821 | 20' HYDRAULIC HOSE ASSESMBLY | 8 |
| 700970 | TWO DRIVE WHEELS FOR 6" PIPE | 8 |
| 701061 | ELECTRIC COUNTER ASSEMBLY | 54 |
| 701358 | STAINLESS STEEL V-BLAD FOR 1697 | 16 |
| 701149 | REPLACEMENT V-SHAPED BLADE PFTE COATED | 16 |
| 701440 | 1 1/2" & 2" ARBOR ASSEMBLY | 50 |
| 701454 | STAINLESS STEEL V-BLAD FOR 1894, 1897 | 16 |
| 701567 | LOW-PROFILE POINTED BLADE FOR 1698 | 16 |
| 701185 | BYPASS VALVE KIT | 9 |
| 802050 | 3/4" CTS ADAPTER | 50 |
| 802051 | 3/4" NPT ADAPTER | 50 |
| 802052 | 1" CTS ADAPTER | 50 |

| Part No | Description | Page |
|---------|--|------|
| 802053 | 1" NPT ADAPTER | 50 |
| 802054 | 1-1/4" CTS ADAPTER | 50 |
| 802055 | 1-1/4" NPT ADAPTER | 50 |
| 802056 | 1-1/2" CTS ADAPTER | 50 |
| 802057 | 1-1/2" NPT ADAPTER | 50 |
| 802058 | 2" CTS ADAPTER | 50 |
| 802059 | 2" NPT ADAPTER | 50 |
| 802060 | 1-1/2" ADAPTER FOR MUELLER 110 | 50 |
| 802061 | 2" ADAPTER FOR MUELLER 110 | 50 |
| 802071 | 3/4" BSPT ADAPTER | 50 |
| 802072 | 1" BSPT ADAPTER | 50 |
| 802073 | 1-1/4" BSPT ADAPTER | 50 |
| 802074 | 1-1/2" BSPT ADAPTER | 50 |
| 802075 | 2" BSPT ADAPTER | 50 |
| 802084 | 1-3/8" PVC CUTTER SHELL | 50 |
| 802085 | 1-7/8" PVC CUTTER | 50 |
| 892100 | REPLACEMENT CUTTING BLADE FOR 89210 | 17 |
| 897065 | DIE HEAD UNIVERSAL MANUAL OPEN 1/8"-2" NPT/NPSM/ UNC/8090 | 28 |
| 903071 | 11/16HSS CUTTER SHELL (502723) | 50 |
| 903072 | 1" HSS CUTTER SHELL 506542 | 50 |
| 903073 | 1-1/4" CUTTER SHELL 506547 | 50 |
| 903074 | 1-1/2" CUTTER SHELL WITH 908097 BUSHING | 50 |
| 903075 | 2" HSS CUTTER SHELL WITH908097 BUSHING | 50 |
| 904065 | 11/16 CUTTER FOR 3/4 DI TAP | 50 |
| 904066 | 7/8 CUTTER FOR 1" DI TAP | 50 |
| 904067 | 1-1/8 DI HS FOR 1-1/4 TAP | 50 |
| 904068 | 1-3/8 CUTTER FOR 1-1/2 DI TAP | 50 |
| 904069 | 1-7/8 CUTTER FOR 2" DI TAP | 50 |
| 908098 | CENTER DRILL W/ COUPON RETAINER | 50 |



WHEELER-REX

3744 Jefferson Rd.
Ashtabula, OH USA 44004

Toll Free: 1-800-321-7950
Fax: 440-992-2925
E-mail: wheeler@wheelerrex.com

wheelerrex.com

© Rex International USA Inc.

Printed in U.S.A.

REX INTERNATIONAL

